

**ERSATZTEILLISTE • SPARE PARTS LIST • LISTE DE PIÈCES DE RECHANGE
LISTINO PEZZI DI RICAMBIO • LISTA DE PIEZAS DE RECAMBIO**

0 5.16

**DREHSCHIEBERPUMPEN • ROTARY VANE PUMPS • POMPES À PALETTES
POMPE A PALETTE • BOMBAS DE PALETAS**

MAKE IT BECKER

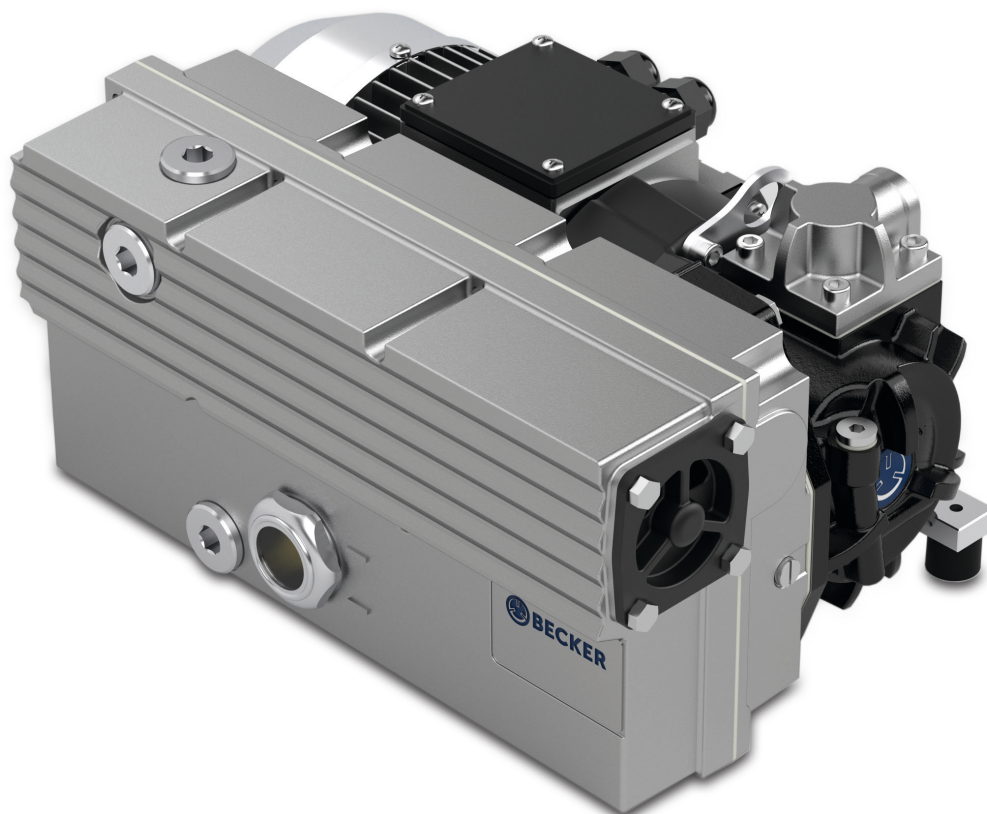

INDEX

INDEX/INDICE

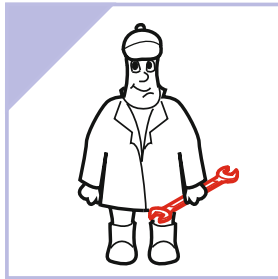

BECKER
D-42279 Wuppertal
www.becker-international.com

year

No

CE type

frequency	XXXX	z
speed	XXXX	min ⁻¹
power required	XXXX	kW
inlet capacity	XXXX	m ³ /h
pressure +	XXXX	mbar
vacuum -	XXXX	mbar

Made in Germany

INDEX

WWW.BECKER-INTERNATIONAL-SHOP.COM

wichtige Komponenten - Serviceteile
important components - Service Parts
composants importants - Pièces de service
importanti componenti - Parti di servizio
componentes importantes - Partes de servicio



INDEX	Pos.	Ident No.	Description	Quantity
	K1	549000 54600	COMPLETE SET OF SEALS	KIT
	K2	555300 55500	OIL SIGHT GLASS KIT	KIT
	K3	955300 55500	SCREW KIT	KIT
	K4	555300 55600	SIEVE KIT	KIT
	K5	555300 55700	SUCTION VALVE KIT	KIT
	K6	555300 55800	FLOAT VALVE KIT	KIT
		960017 00025	BECKER LUBE M 32 (MINERAL OIL)	0,25 l
		960003 20025	BECKER LUBE S 32 (SYNTHETIC OIL)	0,25 l
		960018 00025	BECKER LUBE SL 32 (FOOD SECTOR)	0,25 l
		960023 00300	BECKER LUBE M 68 (MINERAL OIL)	1 l
		960023 00400		5 l
		960023 00500	BECKER LUBE S 68 (SYNTHETIC OIL)	1 l
		960023 00600		5 l
		960023 00700	BECKER LUBE SL 68 (FOOD SECTOR)	1 l
		960023 00800		5 l

0 5.16

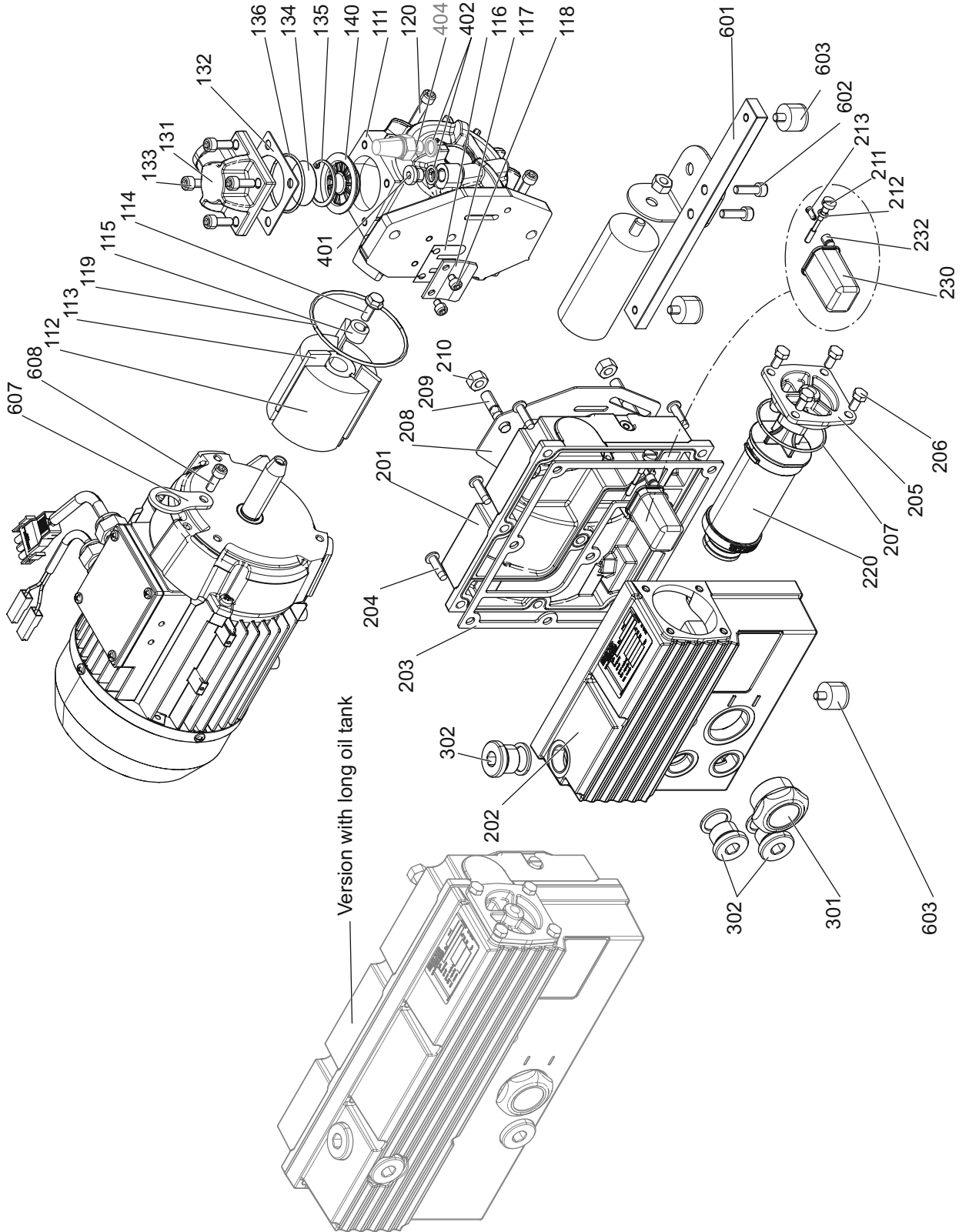



INDEX	Pos.	Bestell Nr.	Beschreibung	DE
	K1	549000 54600	DICHTUNGSSATZ	1)
	K2	555300 55500	ÖLSCHAUGLASSATZ	2)
	K3	955300 55500	SCHRAUBENSATZ	3)
	K4	555300 55600	SIEBSATZ	4)
	K5	555300 55700	SAUGVENTILSATZ	5)
	K6	555300 55800	SCHWIMMERVERTILSATZ	6)
	111	000110 64200	GEHÄUSE	
	112	020000 64200	KOLBEN	
	113	900591 00003	SCHIEBERSATZ	
	114	K3	SECHSKANTSCHRAUBE M6X16	
	115	016700 64300	SPANNBUCHSE	
	116	033910 64300	VENTILPLATTE	
	117	029110 64300	VENTILFÄNGER	
	118	K3	INNENSECHSKANTSCHRAUBE M5X6	
	119	K1	O-RING 74X2,5	
	120	K3	INNENSECHSKANTSCHRAUBE M6X40	
	131	007890 64300	GEWINDEFLANSCH	
	132	K1, K4, K5	DICHTUNG	
	133	K3	INNENSECHSKANTSCHRAUBE M6X16	
	134	K4	SIEB	
	135	948234 00000	SEEGERRING	
	136	K1, K4, K5	O-RING 40X2	
	140	K5	SAUGVENTIL	
	201	002490 64200	ÖLBEHÄLTER A	7)
	201	002490 64300	ÖLBEHÄLTER A	8)
	202	002491 64200	ÖLBEHÄLTER B	7)
	202	002491 64300	ÖLBEHÄLTER B	8)
	203	K1	DICHTUNG	7) 8)
	204	K3	FLACHRUNDKOPFSCHRAUBE M6X20	
	205	003700 64300	WARTUNGSDECKEL	
	206	K3	SECHSKANTSCHRAUBE M6X12	
	207	K1	O-RING 50X2	
	208	K1	DICHTUNG	
	209	K3	STIFTSCHRAUBE M8X20	
	210	K3	SECHSKANTMUTTER M8	
	211	K6	LAGERBOLZEN	
	212	K1, K6	O-RING 4,5X1,8	
	213	K6	DÜSE	
	220	96540064200	LUFTENTÖLELEMENT KOMPLETT	7)
	220	96540064300	LUFTENTÖLELEMENT KOMPLETT	8)
	230	K6	SCHWIMMER	
	232	K1	DICHTELEMENT	
	301	K2	ÖLSCHAUGLAS	
	302	K2	VERSCHLUSSSCHRAUBE G1/2	
	401	951205 00000	VERSCHLUSSSCHRAUBE G1/8	
	402	K1	DICHTRING	
	404	768713 99626	GASBALLASTVENTIL (OPTIONAL)	
	601	015100 64300	FUSS	
	602	K3	INNENSECHSKANTSCHRAUBE M6X20	
	603	741310 80000	GUMMIPUFFER	
	607	025100 64300	TRANSPORTVORRICHTUNG	
	608	K3	INNENSECHSKANTSCHRAUBE M6X16	

INDEX	Pos.	Bestell Nr.	Beschreibung			
		960017 00025	BECKER LUBE M 32 (MINERALÖL)	0,25 l		⁹⁾
		960003 20025	BECKER LUBE S 32 (SYNTHETIKÖL)	0,25 l		⁹⁾
		960018 00025	BECKER LUBE SL 32 (LEBENSMITTELBEREICH)	0,25 l		⁹⁾
		960023 00300	BECKER LUBE M 68 (MINERALÖL)	1 l		¹⁰⁾
		960023 00400		5 l		
		960023 00500	BECKER LUBE S 68 (SYNTHETIKÖL)	1 l		¹⁰⁾
		960023 00600		5 l		
		960023 00700	BECKER LUBE SL 68 (LEBENSMITTELBEREICH)	1 l		¹⁰⁾
		960023 00800		5 l		

- ¹⁾ K1 - DICHTUNGSSATZ → POS.: 119, 132,136, 203, 207, 208, 212, 232, 402
- ²⁾ K2 - ÖLSCHAUGLASSSATZ → POS.: 301, 302
- ³⁾ K3 - SCHRAUBENSATZ → POS.: 114, 118, 120, 133, 204, 206, 209, 210, 602, 608
- ⁴⁾ K4 - SIEBSATZ → POS.: 132, 134, 136
- ⁵⁾ K5 - SAUGVENTILSATZ → POS.: 132, 136, 140
- ⁶⁾ K6 - SCHWIMMERVERTILSATZ → POS.: 211, 212, 213, 230
- ⁷⁾ VERSION - KURZER ÖLBEHÄLTER
- ⁸⁾ VERSION - LANGER ÖLBEHÄLTER
- ⁹⁾ FÜR PUMPEN MIT 1~MOTOR
- ¹⁰⁾ FÜR PUMPEN MIT 3~MOTOR

INDEX	Pos.	Ident No.	Description	
	K1	549000 54600	SET OF SEALS	1)
	K2	555300 55500	OIL SIGHT GLASS KIT	2)
	K3	955300 55500	SCREW KIT	3)
	K4	555300 55600	SIEVE KIT	4)
	K5	555300 55700	SUCTION VALVE KIT	5)
	K6	555300 55800	FLOAT VALVE KIT	6)
	111	000110 64200	HOUSING	
	112	020000 64200	ROTOR	
	113	900591 00003	ROTOR VANE KIT	
	114	K3	HEX HEAD SCREW M6X16	
	115	016700 64300	FIXING SLEEVE	
	116	033910 64300	VALVE PLATE	
	117	029110 64300	VALVE KEEPER	
	118	K3	SOCKET HEAD SCREW M5X6	
	119	K1	O-RING SEAL 74X2,5	
	120	K3	SOCKET HEAD SCREW M6X40	
	131	007890 64300	SCREWED FLANGE	
	132	K1, K4, K5	GASKET	
	133	K3	SOCKET HEAD SCREW M6X16	
	134	K4	SIEVE	
	135	948234 00000	SEEGER CIRCLIP	
	136	K1, K4, K5	O-RING SEAL 40X2	
	140	K5	SUCTION VALVE	
	201	002490 64200	OIL TANK A	7)
	201	002490 64300	OIL TANK A	8)
	202	002491 64200	OIL TANK B	7)
	202	002491 64300	OIL TANK B	8)
	203	K1	GASKET	7) 8)
	204	K3	SOCKET HEAD SCREW M6X20	
	205	003700 64300	MAINTENANCE COVER	
	206	K3	HEX HEAD SCREW M6X12	
	207	K1	O-RING SEAL 50X2	
	208	K1	GASKET	
	209	K3	STUD M8X20	
	210	K3	HEX-NUT M8	
	211	K6	BOLT	
	212	K1, K6	O-RING SEAL 4,5X1,8	
	213	K6	NOZZLE	
	220	96540064200	OIL SEPARATING ELEMENT	7)
	220	96540064300	OIL SEPARATING ELEMENT	8)
	230	K6	FLOAT	
	232	K1	SEALING ELEMENT	
	301	K2	OIL SIGHT GLASS	
	302	K2	SCREW PLUG G1/2	
	401	951205 00000	SCREW PLUG G1/8	
	402	K1	SEALING RING	
	404	768713 99626	GAS BALLAST VALVE (OPTIONAL)	
	601	015100 64300	FOOT	
	602	K3	SOCKET HEAD SCREW M6X20	
	603	741310 80000	BUMPER	
	607	025100 64300	TRANSPORT DEVICE	
	608	K3	SOCKET HEAD SCREW M6X16	

INDEX	Pos.	Ident No.	Description	
		960017 00025	BECKER LUBE M 32 (MINERAL OIL)	0,25 l ⁹⁾
		960003 20025	BECKER LUBE S 32 (SYNTHETIC OIL)	0,25 l ⁹⁾
		960018 00025	BECKER LUBE SL 32 (FOOD SECTOR)	0,25 l ⁹⁾
		960023 00300	BECKER LUBE M 68 (MINERAL OIL)	1 l ¹⁰⁾
		960023 00400		5 l
		960023 00500	BECKER LUBE S 68 (SYNTHETIC OIL)	1 l ¹⁰⁾
		960023 00600		5 l
		960023 00700	BECKER LUBE SL 68 (FOOD SECTOR)	1 l ¹⁰⁾
		960023 00800		5 l

- 1) K1 - SET OF SEALS → POS.: 119, 132,136, 203, 207, 208, 212, 232, 402
- 2) K2 - OIL SIGHT GLASS KIT → POS.: 301, 302
- 3) K3 - SCREW KIT → POS.: 114, 118, 120, 133, 204, 206, 209, 210, 602, 608
- 4) K4 - SIEVE KIT → POS.: 132, 134, 136
- 5) K5 - SUCTION VALVE KIT → POS.: 132, 136, 140
- 6) K6 - FLOAT VALVE KIT → POS.: 211, 212, 213, 230
- 7) VERSION - SHORT OIL TANK
- 8) VERSION - LONG OIL TANK
- 9) FOR PUMPS WITH 1~ MOTOR
- 10) FOR PUMPS WITH 3~ MOTOR

INDEX	Pos.	No. d'identification	Designation	
	K1	549000 54600	JEU DE JOINTS	1)
	K2	555300 55500	ENSEMBLE DE VOYANT D'HUILE	2)
	K3	955300 55500	KIT DE VISSERIE	3)
	K4	555300 55600	KIT TAMIS	4)
	K5	555300 55700	KIT DE SOUPE D'ASPIRATION	5)
	K6	555300 55800	KIT DE SOUPE À FLOTTEUR	6)
	111	000110 64200	CARTER	
	112	020000 64200	PISTON	
	113	900591 00003	KIT DE PALETTES	
	114	K3	VIS SIX-PANS M6X16	
	115	016700 64300	MANCHON DE FIXATION	
	116	033910 64300	PLAQUE DES VANNES	
	117	029110 64300	LIMITEUR DE SOUPE	
	118	K3	VIS À SIX PANS M5X6	
	119	K1	JOINT TORIQUE 74X2,5	
	120	K3	VIS À SIX PANS M6X40	
	131	007890 64300	BRIDE FILETÉE	
	132	K1, K4, K5	JOINT	
	133	K3	VIS À SIX PANS M6X16	
	134	K4	TAMIS	
	135	948234 00000	FREIN D'AXES SEEGER	
	136	K1, K4, K5	JOINT TORIQUE 40X2	
	140	K5	SOUPE D'ASPIRATION	
	201	002490 64200	RÉSERVOIR D'HUILE A	7)
	201	002490 64300	RÉSERVOIR D'HUILE A	8)
	202	002491 64200	RÉSERVOIR D'HUILE B	7)
	202	002491 64300	RÉSERVOIR D'HUILE B	8)
	203	K1	JOINT	7) 8)
	204	K3	VIS À SIX PANS M6X20	
	205	003700 64300	COUVERCLE DE MAINTENANCE	
	206	K3	VIS SIX-PANS M6X12	
	207	K1	JOINT TORIQUE 50X2	
	208	K1	JOINT	
	209	K3	GOUJON PRISONNIER M8X20	
	210	K3	ÉCROU HEXAGONAL M8	
	211	K6	BOULON	
	212	K1, K6	JOINT TORIQUE 4,5X1,8	
	213	K6	AJUTAGE	
	220	96540064200	ELEMENT SEPARATION HUILE	7)
	220	96540064300	ELEMENT SEPARATION HUILE	8)
	230	K6	FLOTTEUR	
	232	K1	JOINT	
	301	K2	JAUGE D'HUILE	
	302	K2	BOUCHON FILETÉ G1/2	
	401	951205 00000	BOUCHON FILETÉ G1/8	
	402	K1	ANNEAU DE JOINT	
	404	768713 99626	L'ESTE D'AIR (EN OPTION)	
	601	015100 64300	PIED	
	602	K3	VIS À SIX PANS M6X20	
	603	741310 80000	AMORTISSEUR CAOUTCHOUC	
	607	025100 64300	DISPOSITIF DE TRANSPORT	
	608	K3	VIS À SIX PANS M6X16	

INDEX	Pos.	No. d'identification	Designation		
		960017 00025	BECKER LUBE M 32 (HUILE MINÉRALE)	0,25 l	9)
		960003 20025	BECKER LUBE S 32 (L'HUILE SYNTHÉTIQUE)	0,25 l	9)
		960018 00025	BECKER LUBE SL 32 (SECTEUR DE L'ALIMENTATION)	0,25 l	9)
		960023 00300	BECKER LUBE M 68 (HUILE MINÉRALE)	1 l	10)
		960023 00400		5 l	
		960023 00500	BECKER LUBE S 68 (L'HUILE SYNTHÉTIQUE)	1 l	10)
		960023 00600		5 l	
		960023 00700	BECKER LUBE SL 68 (SECTEUR DE L'ALIMENTATION)	1 l	10)
		960023 00800		5 l	

1)	K1 - JEU DE JOINTS → POS.: 119, 132,136, 203, 207, 208, 212, 232, 402
2)	K2 - ENSEMBLE DE VOYANT D'HUILE → POS.: 301, 302
3)	K3 - KIT DE VISSERIE → POS.: 114, 118, 120, 133, 204, 206, 209, 210, 602, 608
4)	K4 - KIT TAMIS → POS.: 132, 134, 136
5)	K5 - KIT DE SOUPAPE D'ASPIRATION → POS.: 132, 136, 140
6)	K6 - KIT DE SOUPAPE À FLOTTEUR → POS.: 211, 212, 213, 230
7)	VERSION - RÉSERVOIR D'HUILE COURT
8)	VERSION - RÉSERVOIR D'HUILE LONG
9)	POUR POMPES À 1~ MOTEUR
10)	POUR POMPES À 3~ MOTEUR

INDEX	Pos.	No. identificazione	Designazione	
	K1	549000 54600	KIT DI GUARNIZIONI	1)
	K2	555300 55500	KIT DI SPIA LIVELLO OLIO	2)
	K3	955300 55500	KIT DI VITI	3)
	K4	555300 55600	KIT DI SETACCIO	4)
	K5	555300 55700	KIT VALVOLA ASPIRANTE	5)
	K6	555300 55800	KIT VALVOLA GALLEGGIANTE	6)
	111	000110 64200	CARCASSA	
	112	020000 64200	ROTORE	
	113	900591 00003	KIT DI PALETTE	
	114	K3	VITE ESAGONALE M6X16	
	115	016700 64300	MANICOTTO DI FISSAZIONE	
	116	033910 64300	PIASTRA VALVOLE	
	117	029110 64300	LIMITATORE DELLA VALVOLA	
	118	K3	VITE A BRUGOLA M5X6	
	119	K1	GUARNIZIONE CIRCOLARE 74X2,5	
	120	K3	VITE A BRUGOLA M6X40	
	131	007890 64300	FLANGIA FILETTATA	
	132	K1, K4, K5	GUARNIZIONE	
	133	K3	VITE A BRUGOLA M6X16	
	134	K4	SETACCIO	
	135	948234 00000	ANELLO ELASTICO DI SICUREZZA	
	136	K1, K4, K5	GUARNIZIONE CIRCOLARE 40X2	
	140	K5	VALVOLA ASPIRANTE	
	201	002490 64200	SERBATOIO OLIO A	7)
	201	002490 64300	SERBATOIO OLIO A	8)
	202	002491 64200	SERBATOIO OLIO B	7)
	202	002491 64300	SERBATOIO OLIO B	8)
	203	K1	GUARNIZIONE	7) 8)
	204	K3	VITE A BRUGOLA M6X20	
	205	003700 64300	COPERCHIO DI MANUTENZIONE	
	206	K3	VITE ESAGONALE M6X12	
	207	K1	GUARNIZIONE CIRCOLARE 50X2	
	208	K1	GUARNIZIONE	
	209	K3	VITE PRIGIONIERA M8X20	
	210	K3	DADO ESAGONALE M8	
	211	K6	BULLONE	
	212	K1, K6	GUARNIZIONE CIRCOLARE 4,5X1,8	
	213	K6	UGELLO	
	220	96540064200	CARTUCCIA SEPARATORE OLIO	7)
	220	96540064300	CARTUCCIA SEPARATORE OLIO	8)
	230	K6	GALLEGGIANTE	
	232	K1	GUARNIZIONE	
	301	K2	SPIA LIVELLO OLIO	
	302	K2	TAPPO A VITE G1/2	
	401	951205 00000	TAPPO A VITE G1/8	
	402	K1	ANELLO DI GUARNIZIONE	
	404	768713 99626	VALVOLA DI ZAVORATRICE (OPZIONALE)	
	601	015100 64300	PIE	
	602	K3	VITE A BRUGOLA M6X20	
	603	741310 80000	PINGENTE DI GOMMA	
	607	025100 64300	TRASPORTO DISPOSITIVO	
	608	K3	VITE A BRUGOLA M6X16	

INDEX	Pos.	No. identificazione	Designazione		
		960017 00025	BECKER LUBE M 32 (OLIO MINERALE)	0,25 l	9)
		960003 20025	BECKER LUBE S 32 (OLIO SINTETICO)	0,25 l	9)
		960018 00025	BECKER LUBE SL 32 (SETTORE ALIMENTARE)	0,25 l	9)
		960023 00300	BECKER LUBE M 68 (OLIO MINERALE)	1 l	10)
		960023 00400		5 l	
		960023 00500	BECKER LUBE S 68 (OLIO SINTETICO)	1 l	10)
		960023 00600		5 l	
		960023 00700	BECKER LUBE SL 68 (SETTORE ALIMENTARE)	1 l	10)
		960023 00800		5 l	

1) K1 - KIT DI GUARNIZIONI → POS.: 119, 132,136, 203, 207, 208, 212, 232, 402

2) K2 - KIT DI SPIA LIVELLO OLIO → POS.: 301, 302

3) K3 - KIT DI VITI → POS.: 114, 118, 120, 133, 204, 206, 209, 210, 602, 608

4) K4 - KIT DI SETACCIO → POS.: 132, 134, 136

5) K5 - KIT VALVOLA ASPIRANTE → POS.: 132, 136, 140

6) K5 - KIT VALVOLA GALLEGGIANTE → POS.: 211, 212, 213, 230

7) VERSIONE - SERBATOIO DELL'OLIO CORTO

8) VERSIONE - SERBATOIO OLIO LUNGO

9) PER POMPE CON MOTORE 1~

10) PER POMPE CON MOTORE 3~

INDEX	Pos.	No. de pedido	Descripción	
	K1	549000 54600	KIT DE JUNTAS	1)
	K2	555300 55500	KIT DE MIRILLA DE ACEITE	2)
	K3	955300 55500	KIT DE TORNILLO	3)
	K4	555300 55600	KIT DE TAMIZ	4)
	K5	555300 55700	KIT DE VÁLVULA DE ASPIRACIÓN	5)
	K6	555300 55800	KIT DE VÁLVULA DE FLOTADOR	6)
	111	000110 64200	CARCASA	
	112	020000 64200	ÉMBOLO	
	113	900591 00003	KIT DE EMPUJADOR	
	114	K3	TORNILLO DE CABEZA HEXAGONAL M6X16	
	115	016700 64300	MANGUITO DE FIJACIÓN	
	116	033910 64300	PLACA DE VÁLVULA	
	117	029110 64300	LIMITADOR DE LA VÁLVULA	
	118	K3	TORNILLO CON HEMBRA HEXAGONAL M5X6	
	119	K1	JUNTA TOROIDAL 74X2,5	
	120	K3	TORNILLO CON HEMBRA HEXAGONAL M6X40	
	131	007890 64300	BRIDA HILADA	
	132	K1, K4, K5	JUNTA	
	133	K3	TORNILLO CON HEMBRA HEXAGONAL M6X16	
	134	K4	TAMIZ	
	135	948234 00000	ANILLO DE RETENCIÓN ELÁSTICO	
	136	K1, K4, K5	JUNTA TOROIDAL 40X2	
	140	K5	VÁLVULA DE ASPIRACIÓN	
	201	002490 64200	DEPÓSITO DE ACEITE A	7)
	201	002490 64300	DEPÓSITO DE ACEITE A	8)
	202	002491 64200	DEPÓSITO DE ACEITE B	7)
	202	002491 64300	DEPÓSITO DE ACEITE B	8)
	203	K1	JUNTA	7) 8)
	204	K3	TORNILLO CON HEMBRA HEXAGONAL M6X20	
	205	003700 64300	CUBIERTA DE MANTENIMIENTO	
	206	K3	TORNILLO DE CABEZA HEXAGONAL M6X12	
	207	K1	JUNTA TOROIDAL 50X2	
	208	K1	JUNTA	
	209	K3	ESPÁRRAGO M8X20	
	210	K3	TUERCA HEXAGONAL M8	
	211	K6	BULÓN	
	212	K1, K6	JUNTA TOROIDAL 4,5X1,8	
	213	K6	TOBERA	
	220	96540064200	ELEMENTO DE DESACEITAR DE AIRE	7)
	220	96540064300	ELEMENTO DE DESACEITAR DE AIRE	8)
	230	K6	FLOTADOR	
	232	K1	JUNTA	
	301	K2	CRISTAL MIRILLA DE ACEITE	
	302	K2	TAPÓN ROSCADO G1/2	
	401	951205 00000	TAPÓN ROSCADO G1/8	
	402	K1	ANILLO JUNTA	
	404	768713 99626	VÁLVULA DE LASTRE DE GAS (OPCIONAL)	
	601	015100 64300	PIE	
	602	K3	TORNILLO CON HEMBRA HEXAGONAL M6X20	
	603	741310 80000	AMORTIGUADOR DE CAUCHO	
	607	025100 64300	DISPOSITIVO DE TRANSPORTE	
	608	K3	TORNILLO CON HEMBRA HEXAGONAL M6X16	

INDEX	Pos.	No. de pedido	Descripción	ES	
		960017 00025	BECKER LUBE M 32 (ACEITE MINERAL)	0,25 l	9)
		960003 20025	BECKER LUBE S 32 (ACEITE SINTÉTICO)	0,25 l	9)
		960018 00025	BECKER LUBE SL 32 (SECTOR ALIMENTARIO)	0,25 l	9)
		960023 00300	BECKER LUBE M 68 (ACEITE MINERAL)	1 l	10)
		960023 00400		5 l	
		960023 00500	BECKER LUBE S 68 (ACEITE SINTÉTICO)	1 l	10)
		960023 00600		5 l	
		960023 00700	BECKER LUBE SL 68 (SECTOR ALIMENTARIO)	1 l	10)
		960023 00800		5 l	

- 1) K1 - KIT DE JUNTAS → POS.: 119, 132,136, 203, 207, 208, 212, 232, 402
- 2) K2 - KIT DE MIRILLA DE ACEITE → POS.: 301, 302
- 3) K3 - KIT DE TORNILLO → POS.: 114, 118, 120, 133, 204, 206, 209, 210, 602, 608
- 4) K4 - KIT DE TAMIZ → POS.: 132, 134, 136
- 5) K5 - KIT DE VÁLVULA DE ASPIRACIÓN → POS.: 132, 136, 140
- 6) K6 - KIT DE VÁLVULA DE FLOTADOR → POS.: 211, 212, 213, 230
- 7) VERSIÓN - DEPÓSITO DE ACEITE CORTO
- 8) VERSIÓN - DEPÓSITO DE ACEITE LARGO
- 9) PARA BOMBAS CON MOTOR 1~
- 10) PARA BOMBAS CON MOTOR 3~



28000064200 | 2020-03-03 | All rights reserved

MAKE IT BECKER