

**DT 4.25K**  
**DT 4.40K**

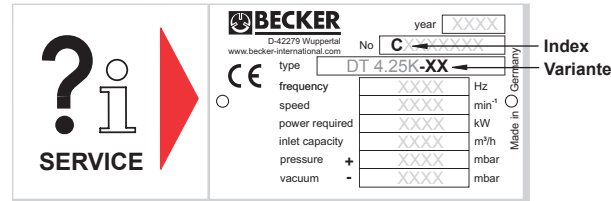
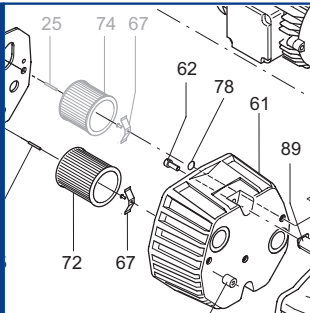

Ersatzteilliste  
Spare parts list  
Liste de pièces de rechange  
Listino pezzi di ricambio  
Lista de piezas de recambio  
Lista de peças sobresselentes  
Reserveonderdelenlijst  
Atsarginių dalių sąrašas  
Varuosad nimekirja  
Rezerves daļu saraksts

Reservedelsliste  
Reservdelslista  
Varaosuettelolo  
Reservedelsliste  
Wykaz części zamiennych  
Tartalékalkatrész lista  
Seznam náhradních dílů  
Seznam nadomestnih delov  
Zoznam náhradných dielov  
Rezervni dijelovi popis

Lista pieselor de schimb  
Páirteanna spártha liosta  
Κατάλογος ανταλλακτικών  
Yedek parça listesi  
Списък на резервните части  
Перечень запасных частей  
スペアパーツリスト  
예비 부품 목록  
备用零件目录

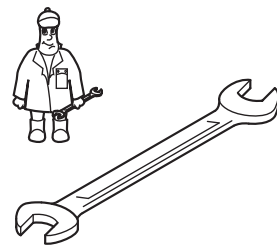

**Wartung**  
**Maintenance**  
**Entretien**  
**Manutenzione**  
**Mantenimiento**



Pos.	Menge <sup>2)</sup> Quantity Quantité Quantità Cantidad	Bestell-Nr. Ident No. No. Identification No. Identificazione No. de pedido	Bezeichnung Description Designation Designazione Descripción
<b>DT 4.25K</b>			
24	SATZ/KIT	901349 00007	Schieber, Rotor Vane, Palette, Empujador
72	1	909505 00000	Filterpatrone, Filter cartridge, Cartouche Filtrante, Cartuccia filtro, Cartucho de filtro
74	1	909529 00000	Filterpatrone, Filter cartridge, Cartouche Filtrante, Cartuccia filtro, Cartucho de filtro
<b>DT 4.40K</b>			
24	SATZ/KIT	901352 00007	Schieber, Rotor Vane, Palette, Empujador (DT 4.40K/5-63)
24		901391 00007	
72	1	909505 00000	Filterpatrone, Filter cartridge, Cartouche Filtrante, Cartuccia filtro, Cartucho de filtro
74	1	909529 00000	Filterpatrone, Filter cartridge, Cartouche Filtrante, Cartuccia filtro, Cartucho de filtro

<sup>2)</sup> erforderliche Bestellmenge / necessary order quantity / quantité nécessaire / quantità di ordinazione necessari / cantidad necesario

DT 4.25K  
 DT 4.40K

Standard



Variante



DT 4.25K/XX

- ①  
 1~ Einphasenwechselstrom  
 1~ single-phase AC  
 1~ AC monophasé  
 1~ AC monofase  
 1~ AC monofásica

DT 4.40K/XX

- ②  
 1~ Einphasenwechselstrom  
 1~ single-phase AC  
 1~ AC monophasé  
 1~ AC monofase  
 1~ AC monofásica

③ /5-63

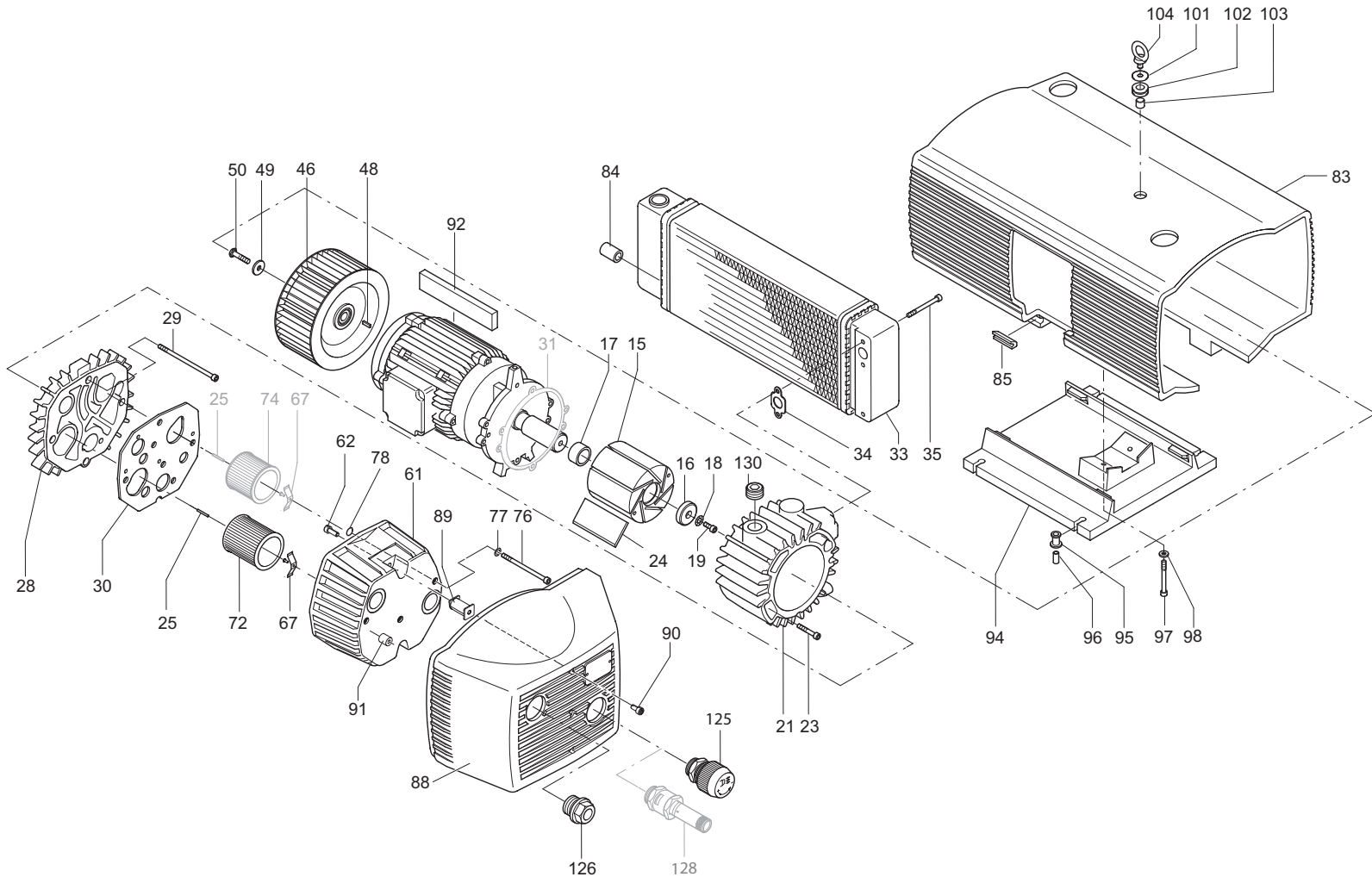

SERVICE ?

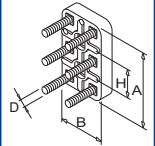
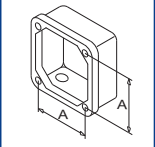
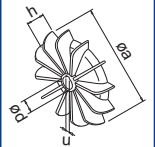
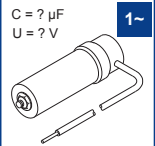
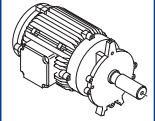

C INDEX	Pos.	Bestell Nr.	Beschreibung	
DT 4.25K	15	020000 16400	KOLBEN	
	16	016800 16500	SPANNSCHEIBE	
	17	911012 00000	STAR-TOLERANZRING	
	18	949203 00000	ZAHNSCHEIBE	
	19	945320 00000	INNENSECHSKANTSCHRAUBE	
	21	000100 27500	GEHÄUSE	
	23	945320 00000	INNENSECHSKANTSCHRAUBE	
	24	901349 00007	<b>SCHIEBER, KOHLE (SATZ)</b>	
	25	952009 00000	SPANNHÜLSE	
	28	000701 27600	SEITENDECKEL	
	29	945373 00000	INNENSECHSKANTSCHRAUBE	
	30	008900 16500	DICHTUNG	
	33	560200 27500	KÜHLER	
34	005700 27600	DICHTUNG		
35	945325 00000	INNENSECHSKANTSCHRAUBE		
46	502300 16400	VENTILATOR		
48	947713 00000	PASSFEDER		
49	949454 00000	UNTERLEGSCHEIBE		
50	901804 00000	WELLENENDSCHRAUBE		
61	004804 27600	FILTERDECKEL		
62	945319 00000	INNENSECHSKANTSCHRAUBE		
67	009000 16300	ANPRESSFEDER		
72	909505 00000	<b>FILTERPATRONE (1x) <sup>1)</sup></b>		
74	909529 00000	<b>FILTERPATRONE - OPTIONAL</b>		
76	945373 00000	INNENSECHSKANTSCHRAUBE		
77	948021 00000	DICHTRING		
78	913161 00000	O-RING		
83	006800 27500	GERÄTEHAUBE		
84	742609 01000	SCHLAUCH		
85	951920 00000	GUMMIFORMTEIL		
88	006803 27600	FRONTHAUBE		
89	741300 27601	DÄMMAUFLAGE		
90	945318 00000	INNENSECHSKANTSCHRAUBE		
91	951922 00000	GUMMIFORMTEIL		
92	964108 00000	KANTENSCHUTZ		
94	015100 27600	FUSS		
95	951921 00000	GUMMIFORMTEIL		
96	068000 27600	DISTANZSTÜCK		
97	945328 00000	INNENSECHSKANTSCHRAUBE		
98	949451 00000	UNTERLEGSCHEIBE		
101	833903 99597	VENTILTeller		
102	951906 00000	KABELTÜLLE		
103	068002 16500	DISTANZROHR		
104	548800 16300	RINGSCHRAUBE		
111	913161 00000	O-RING		
112	741300 27600	GUMMISCHEIBE		
125	728003 99611	DRUCKREGULIERVENTIL		
126	943132 00000	DÜSE		
130	951225 00000	VERSCHLUSS-SCHRAUBE		

<sup>1)</sup> erforderliche Bestellmenge / Wartung

C INDEX	Pos.	Bestell Nr.	Beschreibung	
DT 4.40K	15	020000 16500	KOLBEN	
	16	016800 16500	SPANNSCHEIBE	
	17	911008 00000	STAR TOLERANZRING	
	18	949203 00000	ZAHNSCHEIBE	
	19	945320 00000	INNENSECHSKANTSCHRAUBE	
	21	000100 27600	GEHÄUSE	
	23	945322 00000	INNENSECHSKANTSCHRAUBE	
	24	901352 00007	<b>SCHIEBER, KOHLE (SATZ)</b>	
	25	952009 00000	SPANNHÜLSE	
	28	000701 27600	SEITENDECKEL	
	29	945374 00000	INNENSECHSKANTSCHRAUBE	
	30	008900 16500	DICHTUNG	
	33	560200 27600	DRUCKLUFTKÜHLER	
34	005700 27600	DICHTUNG		
35	945325 00000	INNENSECHSKANTSCHRAUBE		
46	902300 27600	VENTILATOR		
48	947713 00000	PASSFEDER		
49	949454 00000	UNTERLEGSCHEIBE		
50	901804 00000	WELLENENDSCHRAUBE		
61	004804 27600	FILTERDECKEL		
62	945319 00000	INNENSECHSKANTSCHRAUBE		
67	009000 16300	ANPRESSFEDER		
72	909505 00000	<b>FILTERPATRONE (1x) <sup>1)</sup></b>		
74	909529 00000	<b>FILTERPATRONE - OPTIONAL</b>		
76	945373 00000	INNENSECHSKANTSCHRAUBE		
77	948021 00000	DICHTRING		
78	913161 00000	O-RING		
83	006800 27600	GERÄTEHAUBE		
84	742609 01000	SCHLAUCH		
85	951920 00000	GUMMIFORMTEIL		
88	006803 27600	FRONTHAUBE		
89	741300 27601	DÄMMAUFLAGE		
90	945318 00000	INNENSECHSKANTSCHRAUBE		
91	951922 00000	GUMMIFORMTEIL		
92	964108 00000	KANTENSCHUTZ		
94	015100 27600	FUSS		
95	951921 00000	GUMMIFORMTEIL		
96	068000 27600	DISTANZSTÜCK		
97	945328 00000	INNENSECHSKANTSCHRAUBE		
98	949451 00000	UNTERLEGSCHEIBE		
101	833903 99597	VENTILTeller		
102	951906 00000	KABELTÜLLE		
103	068002 16500	DISTANZROHR		
104	548800 16300	RINGSCHRAUBE		
111	913161 00000	O-RING		
112	741300 27600	GUMMISCHEIBE		
125	728003 99611	DRUCKREGULIERVENTIL		
126	943133 00000	DÜSE		
130	951225 00000	VERSCHLUSS-SCHRAUBE		

<sup>1)</sup> erforderliche Bestellmenge / Wartung

C INDEX	Pos.	Ident No.	Description	
DT 4.25K	15	020000 16400	ROTOR	
	16	016800 16500	CLAMPING DISC	
	17	911012 00000	STAR-TOLERANCE-RING	
	18	949203 00000	TOOTHED SPRING WASHER	
	19	945320 00000	SOCKET HEAD SCREW	
	21	000100 27500	PUMP BODY	
	23	945320 00000	SOCKET HEAD SCREW	
	24	901349 00007	<b>CARBON VANES (KIT)</b>	
	25	952009 00000	LOCATING PEG	
	28	000701 27600	LID	
	29	945373 00000	SOCKET HEAD SCREW	
	30	008900 16500	GASKET	
	33	560200 27500	COOLER	
34	005700 27600	GASKET		
35	945325 00000	SOCKET HEAD SCREW		
46	502300 16400	FAN		
48	947713 00000	KEY		
49	949454 00000	WASHER		
50	901804 00000	SHAFT END BOLD		
61	004804 27600	FILTER COVER		
62	945319 00000	SOCKET HEAD SCREW		
67	009000 16300	LEAF SPRING		
72	909505 00000	<b>FILTER CARTRIDGE (1x) <sup>1)</sup></b>		
74	909529 00000	<b>FILTER CARTRIDGE - OPTIONAL</b>		
76	945373 00000	SOCKET HEAD SCREW		
77	948021 00000	SEALING RING		
78	913161 00000	O-RING		
83	006800 27500	PROTECTING HOOD		
84	742609 01000	TUBE FLEXIBLE		
85	951920 00000	RUBBER ELEMENT		
88	006803 27600	PROTECTING HOOD		
89	741300 27601	VIBRATION DAMPER		
90	945318 00000	SOCKET HEAD SCREW		
91	951922 00000	RUBBER ELEMENT		
92	964108 00000	EDGE PROTECTION		
94	015100 27600	FOOT		
95	951921 00000	RUBBER ELEMENT		
96	068000 27600	SPACING COLLAR		
97	945328 00000	SOCKET HEAD SCREW		
98	949451 00000	WASHER		
101	833903 99597	VALVE DISC		
102	951906 00000	RUBBER BUSHING		
103	068002 16500	SPACER TUBE		
104	548800 16300	RING SCREW		
111	913161 00000	O-RING		
112	741300 27600	RUBBER DISC		
125	728003 99611	PRESSURE REGUL. VALVE		
126	943132 00000	NOZZLE		
130	951225 00000	LOCKING SCREW		

<sup>1)</sup> necessary order quantity / maintenance

C INDEX	Pos.	Ident No.	Description	
DT 4.40K	15	020000 16500	ROTOR	
	16	016800 16500	CLAMPING DISC	
	17	911008 00000	STAR-TOLERANCE-RING	
	18	949203 00000	TOOTHED SPRING WASHER	
	19	945320 00000	SOCKET HEAD SCREW	
	21	000100 27600	PUMP BODY	
	23	945322 00000	SOCKET HEAD SCREW	
	24	901352 00007	<b>CARBON VANES (KIT)</b>	
	25	952009 00000	LOCATING PEG	
	28	000701 27600	LID	
	29	945374 00000	SOCKET HEAD SCREW	
	30	008900 16500	GASKET	
	33	560200 27600	COOLER	
34	005700 27600	GASKET		
35	945325 00000	SOCKET HEAD SCREW		
46	902300 27600	FAN		
48	947713 00000	KEY		
49	949454 00000	WASHER		
50	901804 00000	SHAFT END BOLD		
61	004804 27600	FILTER COVER		
62	945319 00000	SOCKET HEAD SCREW		
67	009000 16300	LEAF SPRING		
72	909505 00000	<b>FILTER CARTRIDGE (1x) <sup>1)</sup></b>		
74	909529 00000	<b>FILTER CARTRIDGE - OPTIONAL</b>		
76	945373 00000	SOCKET HEAD SCREW		
77	948021 00000	SEALING RING		
78	913161 00000	O-RING		
83	006800 27600	PROTECTING HOOD		
84	742609 01000	TUBE FLEXIBLE		
85	951920 00000	RUBBER ELEMENT		
88	006803 27600	PROTECTING HOOD		
89	741300 27601	VIBRATION DAMPER		
90	945318 00000	SOCKET HEAD SCREW		
91	951922 00000	RUBBER ELEMENT		
92	964108 00000	EDGE PROTECTION		
94	015100 27600	FOOT		
95	951921 00000	RUBBER ELEMENT		
96	068000 27600	SPACING COLLAR		
97	945328 00000	SOCKET HEAD SCREW		
98	949451 00000	WASHER		
101	833903 99597	VALVE DISC		
102	951906 00000	RUBBER BUSHING		
103	068002 16500	SPACER TUBE		
104	548800 16300	RING SCREW		
111	913161 00000	O-RING		
112	741300 27600	RUBBER DISC		
125	728003 99611	PRESSURE REGUL. VALVE		
126	943133 00000	NOZZLE		
130	951225 00000	LOCKING SCREW		

<sup>1)</sup> necessary order quantity / maintenance

C INDICE	Pos.	No. Identification	Designation	FR	
DT 4.25K	15	020000 16400	PISTON		
	16	016800 16500	DISQUE DE SERRAGE		
	17	911012 00000	BAGUE STAR		
	18	949203 00000	DENT DISQUE		
	19	945320 00000	VIS HEXAGONALE INTERNE		
	21	000100 27500	CORP DE POMPE		
	23	945320 00000	VIS HEXAGONALE INTERNE		
	24	901349 00007	<b>PALETTE DE CHARBON (KIT)</b>		
	25	952009 00000	DOVILLE DE ETRAGE		
	28	000701 27600	COUVERCLE		
	29	945373 00000	VIS HEXAGONALE INTERNE		
	30	008900 16500	JOINT		
	33	560200 27500	REFROIDISSEUR		
34	005700 27600	JOINT			
35	945325 00000	VIS HEXAGONALE INTERNE			
46	502300 16400	VENTILATEUR			
48	947713 00000	CLAVETTE			
49	949454 00000	RONDELLE			
50	901804 00000	VIS BOUT D'ARBRE			
61	004804 27600	COUVERCLE DU FILTRE			
62	945319 00000	VIS HEXAGONALE INTERNE			
67	009000 16300	RESSORT-JAME			
72	909505 00000	<b>CARTOUCHE FILTRANTE (1x) <sup>1)</sup></b>			
74	909529 00000	<b>CARTOUCHE FILTRANTE - EN OPTION</b>			
76	945373 00000	VIS HEXAGONALE INTERNE			
77	948021 00000	JOINT			
78	913161 00000	ANNEAU-O			
83	006800 27500	CARTER PROTECTEUR			
84	742609 01000	TUBE FLEXIBLE			
85	951920 00000	ELEMENT EN CAOUTCHOUC			
88	006803 27600	CARTER PROTECTEUR			
89	741300 27601	AMORTISSEUR DE VIBRATIONS			
90	945318 00000	VIS HEXAGONALE INTERNE			
91	951922 00000	ELEMENT EN CAOUTCHOUC			
92	964108 00000	PROTECTION D'ARETE			
94	015100 27600	PIED			
95	951921 00000	ELEMENT EN CAOUTCHOUC			
96	068000 27600	DONILLE D'ECARMENT			
97	945328 00000	VIS HEXAGONALE INTERNE			
98	949451 00000	RONDELLE			
101	833903 99597	PLATEAU DE SOUPAPE			
102	951906 00000	PROTECTION EN CAOUTCHOUC			
103	068002 16500	TUBE D'ECARTEMENT			
104	548800 16300	PITON			
111	913161 00000	ANNEAU-O			
112	741300 27600	RONDELLE DE CAOUTCHOUC			
125	728003 99611	SOUPAPE REGLAGE PRESSION			
126	943132 00000	GICLEUR			
130	951225 00000	BOUCHON			

<sup>1)</sup> quantité nécessaire / entretien

C INDICE	Pos.	No. Identification	Designation	FR	
DT 4.40K	15	020000 16500	PISTON		
	16	016800 16500	DISQUE DE SERRAGE		
	17	911008 00000	BAGUE STAR		
	18	949203 00000	DENT DISQUE		
	19	945320 00000	VIS HEXAGONALE INTERNE		
	21	000100 27600	CORP DE POMPE		
	23	945322 00000	VIS HEXAGONALE INTERNE		
	24	901352 00007	<b>PALETTE DE CHARBON (KIT)</b>		
	25	952009 00000	DOVILLE DE ETRAGE		
	28	000701 27600	COUVERCLE		
	29	945374 00000	VIS HEXAGONALE INTERNE		
	30	008900 16500	JOINT		
	33	560200 27600	REFROIDISSEUR		
34	005700 27600	JOINT			
35	945325 00000	VIS HEXAGONALE INTERNE			
46	902300 27600	VENTILATEUR			
48	947713 00000	CLAVETTE			
49	949454 00000	RONDELLE			
50	901804 00000	VIS BOUT D'ARBRE			
61	004804 27600	COUVERCLE DU FILTRE			
62	945319 00000	VIS HEXAGONALE INTERNE			
67	009000 16300	RESSORT-JAME			
72	909505 00000	<b>CARTOUCHE FILTRANTE (1x) <sup>1)</sup></b>			
74	909529 00000	<b>CARTOUCHE FILTRANTE - EN OPTION</b>			
76	945373 00000	VIS HEXAGONALE INTERNE			
77	948021 00000	JOINT			
78	913161 00000	ANNEAU-O			
83	006800 27600	CARTER PROTECTEUR			
84	742609 01000	TUBE FLEXIBLE			
85	951920 00000	ELEMENT EN CAOUTCHOUC			
88	006803 27600	CARTER PROTECTEUR			
89	741300 27601	AMORTISSEUR DE VIBRATIONS			
90	945318 00000	VIS HEXAGONALE INTERNE			
91	951922 00000	ELEMENT EN CAOUTCHOUC			
92	964108 00000	PROTECTION D'ARETE			
94	015100 27600	PIED			
95	951921 00000	ELEMENT EN CAOUTCHOUC			
96	068000 27600	DONILLE D'ECARMENT			
97	945328 00000	VIS HEXAGONALE INTERNE			
98	949451 00000	RONDELLE			
101	833903 99597	PLATEAU DE SOUPAPE			
102	951906 00000	PROTECTION EN CAOUTCHOUC			
103	068002 16500	TUBE D'ECARTEMENT			
104	548800 16300	PITON			
111	913161 00000	ANNEAU-O			
112	741300 27600	RONDELLE DE CAOUTCHOUC			
125	728003 99611	SOUPAPE REGLAGE PRESSION			
126	943133 00000	GICLEUR			
130	951225 00000	BOUCHON			

<sup>1)</sup> quantité nécessaire / entretien

C INDICE	Pos.	No. Identificazione	Designazione		
DT 4.25K	15	020000 16400	ROTORE		
	16	016800 16500	DISCO DI FISSAGGIO		
	17	911012 00000	STAR-ANELLO TOLLERANZA		
	18	949203 00000	DISCO A DENTE		
	19	945320 00000	VITE ESAGONALE INTERNA		
	21	000100 27500	CARCASSA		
	23	945320 00000	VITE ESAGONALE INTERNA		
	24	901349 00007	<b>PALETTE DI CHARBONE (KIT)</b>		
	25	952009 00000	SPINE DI RISCONTRO		
	28	000701 27600	COPERCHIO		
	29	945373 00000	VITE ESAGONALE INTERNA		
	30	008900 16500	GUARNIZIONE		
	33	560200 27500	RAFFREDDATORE		
34	005700 27600	GUARNIZIONE			
35	945325 00000	VITE ESAGONALE INTERNA			
46	502300 16400	VENTILATORE			
48	947713 00000	CHIAVETTA			
49	949454 00000	RONDELLA			
50	901804 00000	VITE DI CHIUSURA ALBERO			
61	004804 27600	COPERCHIO FILTRO			
62	945319 00000	VITE ESAGONALE INTERNA			
67	009000 16300	MOLLA			
72	909505 00000	<b>CARTUCCIA FILTRO (1x) <sup>1)</sup></b>			
74	909529 00000	<b>CARTUCCIA FILTRO - OPZIONALE</b>			
76	945373 00000	VITE ESAGONALE INTERNA			
77	948021 00000	ANELLO GUARNIZIONE			
78	913161 00000	ANELLO-O			
83	006800 27500	CARTER DI PROTEZIONE			
84	742609 01000	TUBO FLESSIBILE			
85	951920 00000	ELEMENTO IN GOMMA			
88	006803 27600	CARTER DI PROTEZIONE			
89	741300 27601	AMMORTIZZATORE DI VIBRAZIONI			
90	945318 00000	VITE ESAGONALE INTERNA			
91	951922 00000	ELEMENTO IN GOMMA			
92	964108 00000	LISTELLO DI PROTEZIONE			
94	015100 27600	PIEDE			
95	951921 00000	ELEMENTO IN GOMMA			
96	068000 27600	BOCCOLA DISTANZIATRICE			
97	945328 00000	VITE ESAGONALE INTERNA			
98	949451 00000	RONDELLA			
101	833903 99597	PIATELLO DELLA VALVOLA			
102	951906 00000	PROTEZIONE IN GOMMA			
103	068002 16500	TUBO DISTANZA			
104	548800 16300	GANCIO			
111	913161 00000	ANELLO-O			
112	741300 27600	RONDELLA IN GOMMA			
125	728003 99611	VALVOLA REGOLAZIONE PRESS.			
126	943132 00000	UGELLO			
130	951225 00000	VITE DI CHIUSURA			

<sup>1)</sup> quantità di ordinazione necessari / manutenzione

C INDICE	Pos.	No. Identificazione	Designazione		
DT 4.40K	15	020000 16500	ROTORE		
	16	016800 16500	DISCO DI FISSAGGIO		
	17	911008 00000	STAR-ANELLO TOLLERANZA		
	18	949203 00000	DISCO A DENTE		
	19	945320 00000	VITE ESAGONALE INTERNA		
	21	000100 27600	CARCASSA		
	23	945322 00000	VITE ESAGONALE INTERNA		
	24	901352 00007	<b>PALETTE DI CHARBONE (KIT)</b>		
	25	952009 00000	SPINE DI RISCONTRO		
	28	000701 27600	COPERCHIO		
	29	945374 00000	VITE ESAGONALE INTERNA		
	30	008900 16500	GUARNIZIONE		
	33	560200 27600	RADIATORE		
34	005700 27600	GUARNIZIONE			
35	945325 00000	VITE ESAGONALE INTERNA			
46	902300 27600	VENTILATORE			
48	947713 00000	CHIAVETTA			
49	949454 00000	RONDELLA			
50	901804 00000	VITE DI CHIUSURA ALBERO			
61	004804 27600	COPERCHIO FILTRO			
62	945319 00000	VITE ESAGONALE INTERNA			
67	009000 16300	MOLLA			
72	909505 00000	<b>CARTUCCIA FILTRO (1x) <sup>1)</sup></b>			
74	909529 00000	<b>CARTUCCIA FILTRO - OPZIONALE</b>			
76	945373 00000	VITE ESAGONALE INTERNA			
77	948021 00000	ANELLO GUARNIZIONE			
78	913161 00000	ANELLO-O			
83	006800 27600	CARTER DI PROTEZIONE			
84	742609 01000	TUBO FLESSIBILE			
85	951920 00000	ELEMENTO IN GOMMA			
88	006803 27600	CARTER DI PROTEZIONE			
89	741300 27601	AMMORTIZZATORE DI VIBRAZIONI			
90	945318 00000	VITE ESAGONALE INTERNA			
91	951922 00000	ELEMENTO IN GOMMA			
92	964108 00000	LISTELLO DI PROTEZIONE			
94	015100 27600	PIEDE			
95	951921 00000	ELEMENTO IN GOMMA			
96	068000 27600	BOCCOLA DISTANZIATRICE			
97	945328 00000	VITE ESAGONALE INTERNA			
98	949451 00000	RONDELLA			
101	833903 99597	PIATELLO DELLA VALVOLA			
102	951906 00000	PROTEZIONE IN GOMMA			
103	068002 16500	TUBO DISTANZA			
104	548800 16300	GANCIO			
111	913161 00000	ANELLO-O			
112	741300 27600	RONDELLA IN GOMMA			
125	728003 99611	VALVOLA REGOLAZIONE PRESS.			
126	943133 00000	UGELLO			
130	951225 00000	VITE DI CHIUSURA			



<sup>1)</sup> quantità di ordinazione necessari / manutenzione

C INDICE	Pos.	No. De pedido	Descripción		
DT 4.25K	15	020000 16400	ÉMBOLO		
	16	016800 16500	ARANDELA TENSORA		
	17	911012 00000	ANILLO DE TOLERANCIA STAR		
	18	949203 00000	POLEA DENTADA		
	19	945320 00000	TORNILLO HEXAGONAL		
	21	000100 27500	CARCASA		
	23	945320 00000	TORNILLO HEXAGONAL INTERIOR		
	24	901349 00007	<b>EMPUJADOR DE CARBÓN (KIT)</b>		
	25	952009 00000	CASQUILLO TENSOR		
	28	000701 27600	TAPA LATERAL		
	29	945373 00000	TORNILLO HEXAGONAL INTERIOR		
	30	008900 16500	JUNTA		
	33	560200 27500	REFRIGERADOR		
	34	005700 27600	JUNTA		
	35	945325 00000	TORNILLO HEXAGONAL INTERIOR		
	46	502300 16400	VENTILADOR		
	48	947713 00000	LENGÜETA DE AJUSTE		
	49	949454 00000	ARANDELA		
	50	901804 00000	TORNILLO TERMINAL DE ÁRBOL		
	61	004804 27600	TAPA DE FILTRO		
	62	945319 00000	TORNILLO HEXAGONAL INTERIOR		
	67	009000 16300	MUELLE DE PRESIÓN		
	72	909505 00000	<b>CARTUCHO DE FILTRO (1x) <sup>1)</sup></b>		
	74	909529 00000	<b>CARTUCHO DE FILTRO - OPCIONAL</b>		
	76	945373 00000	TORNILLO HEXAGONAL INTERIOR		
	77	948021 00000	ANILLO DE JUNTA		
	78	913161 00000	JUNTA TÓRICA		
	83	006800 27500	CAPERUZA DE APARATO		
	84	742609 01000	MANGUERA		
	85	951920 00000	PIEZA DE ORMA DE GOMA		
	88	006803 27600	CAPERUZA DE APARATO		
	89	741300 27601	AMORTIGUADOR DE VIBRACIONES		
	90	945318 00000	TORNILLO HEXAGONAL INTERIOR		
91	951922 00000	PIEZA DE ORMA DE GOMA			
92	964108 00000	PROTECCIÓN DE CANTOS			
94	015100 27600	PIE			
95	951921 00000	PIEZA DE ORMA DE GOMA			
96	068000 27600	PIEZA DISTANCIADORA			
97	945328 00000	TORNILLO HEXAGONAL INTERIOR			
98	949451 00000	ARANDELA			
101	833903 99597	PLATILLO DE VÁLVULA			
102	951906 00000	BOQUILLA DE CABLE			
103	068002 16500	TUBO DISTANCIADOR			
104	548800 16300	TORNILLO DE CÁNCAMO			
111	913161 00000	JUNTA TÓRICA			
112	741300 27600	ARANDELA DE GOMA			
125	728003 99611	VÁLVULA REGULADORA DE PRESIÓN			
126	943132 00000	TOBERA			
130	951225 00000	TORNILLO DE CIERRE			

<sup>1)</sup> cantidad necesario / mantenimiento

C INDICE	Pos.	No. De pedido	Descripción		
DT 4.40K	15	020000 16500	ÉMBOLO		
	16	016800 16500	ARANDELA TENSORA		
	17	911008 00000	ANILLO DE TOLERANCIA STAR		
	18	949203 00000	POLEA DENTADA		
	19	945320 00000	TORNILLO HEXAGONAL INTERIOR		
	21	000100 27600	CARCASA		
	23	945322 00000	TORNILLO HEXAGONAL INTERIOR		
	24	901352 00007	<b>EMPUJADOR DE CARBÓN (KIT)</b>		
	25	952009 00000	CASQUILLO TENSOR		
	28	000701 27600	TAPA LATERAL		
	29	945374 00000	TORNILLO HEXAGONAL INTERIOR		
	30	008900 16500	JUNTA		
	33	560200 27600	REFRIGERADOR DE AIRE COMPRIMIDO		
	34	005700 27600	JUNTA		
	35	945325 00000	TORNILLO HEXAGONAL INTERIOR		
	46	902300 27600	VENTILADOR		
	48	947713 00000	LENGÜETA DE AJUSTE		
	49	949454 00000	ARANDELA		
	50	901804 00000	TORNILLO TERMINAL DE ÁRBOL		
	61	004804 27600	TAPA DE FILTRO		
	62	945319 00000	TORNILLO HEXAGONAL INTERIOR		
	67	009000 16300	MUELLE DE PRESIÓN		
	72	909505 00000	<b>CARTUCHO DE FILTRO (1x) <sup>1)</sup></b>		
	74	909529 00000	<b>CARTUCHO DE FILTRO - OPCIONAL</b>		
	76	945373 00000	TORNILLO HEXAGONAL INTERIOR		
	77	948021 00000	ANILLO DE JUNTA		
	78	913161 00000	JUNTA TÓRICA		
	83	006800 27600	CAPERUZA DE APARATO		
	84	742609 01000	MANGUERA		
	85	951920 00000	PIEZA DE ORMA DE GOMA		
	88	006803 27600	CAPERUZA DE APARATO		
	89	741300 27601	AMORTIGUADOR DE VIBRACIONES		
	90	945318 00000	TORNILLO HEXAGONAL INTERIOR		
91	951922 00000	PIEZA DE ORMA DE GOMA			
92	964108 00000	PROTECCIÓN DE CANTOS			
94	015100 27600	PIE			
95	951921 00000	PIEZA DE ORMA DE GOMA			
96	068000 27600	PIEZA DISTANCIADORA			
97	945328 00000	TORNILLO HEXAGONAL INTERIOR			
98	949451 00000	ARANDELA			
101	833903 99597	PLATILLO DE VÁLVULA			
102	951906 00000	BOQUILLA DE CABLE			
103	068002 16500	TUBO DISTANCIADOR			
104	548800 16300	TORNILLO DE CÁNCAMO			
111	913161 00000	JUNTA TÓRICA			
112	741300 27600	ARANDELA DE GOMA			
125	728003 99611	VÁLVULA REGULADORA DE PRESIÓN			
126	943133 00000	TOBERA			
130	951225 00000	TORNILLO DE CIERRE			

<sup>1)</sup> cantidad necesario / mantenimiento

DT 4.25K DT 4.40K	Variante 	Pos. <sup>2)</sup>	Bestell Nr. / Ident No. / No. Identification / No. Identificazione / No. De pedido		Beschreibung / Description / Designation / Designazione / Desripcion
					
<b>DT 4.25K</b>					
① 1~ Einphasenwechselstrom 1~ single-phase AC 1~ AC monophasé 1~ AC monofase 1~ AC monofásica		8	964233 00000		WINKEL / BRACKET / COUDES / GOMITO / ÁNGULO
		12	948766 00000		BLINDNIET / BLIND RIVET / RIVET AVEUGLIE / RIVETTO CIECO / REMACHE CIEGO
		13	742002 30000		KABEL / CABLE / CABLE / CAVO / CABLE
		83	006802 27500	<del>006800-27500</del>	HAUBE / PROTECTING HOOD / CARTER PROTECTEUR / CARTER DI PROTEZIONE / CAPERUZA
		94	015101 27600	<del>015100-27600</del>	FUSS / FOOT / PIED / PIEDE / PIE
<b>DT 4.40K</b>					
② 1~ Einphasenwechselstrom 1~ single-phase AC 1~ AC monophasé 1~ AC monofase 1~ AC monofásica		8	964233 00000		WINKEL / BRACKET / COUDES / GOMITO / ÁNGULO
		12	948766 00000		BLINDNIET / BLIND RIVET / RIVET AVEUGLIE / RIVETTO CIECO / REMACHE CIEGO
		13	742002 30000		KABEL / CABLE / CABLE / CAVO / CABLE
		83	006804 27600	<del>006800-27600</del>	HAUBE / PROTECTING HOOD / CARTER PROTECTEUR / CARTER DI PROTEZIONE / CAPERUZA
		94	015101 27600	<del>015100-27600</del>	FUSS / FOOT / PIED / PIEDE / PIE
③ /5-63 <sup>1)</sup> 3~ für erhöhten Druck 3~ for increased pressure 3~ pour une pression accrue 3~ per aumento della pressione 3~ por aumento de la presión		21	000101 27600	<del>000100-27600</del>	GEHÄUSE / PUMP BODY / CORP DE POMPE / CARCASSA / CARCASA
		24	901391 00007	<del>901352-00007</del>	SCHIEBER / CARBON VANES / PALETTE DE CHARBON / PALETTE DI CHARBONE / EMPUJADOR DE CARBÓN
		31	903237 00000		DICHTUNG / GASKET / JOINT / GUARNIZIONE / JUNTA
		125		<del>728003-99614</del>	DRUCKREGULIERVENTIL / PRESSURE REGUL. VALVE / SOUPAPE REGLAGE PRESSION / VALVOLA REGOLAZIONE PRESS. / VÁLVULA REGULADORA DE PRESIÓN
		128	734000 02000		DRUCKSICHERHEITSVENTIL / RELIEF VALVE / SOUPAPE DE SÉCURITÉ / VALVOLA DI SICUREZZA / VÁLVULA DE SEGURIDAD

<sup>1)</sup> nur für Kurzzeitbetrieb (max. 5 min. + 10 min. Leerlauf) / only for short-time operation suitable (max. 5 min. + 10 min. neutral) / approprié seulement pour un service temporaire (max. 5 min. + 10 min. marche à vide) / solamente per operazione a breve tempo (mas. 5 min. + 10 min. marcia in folle) / sólo para la operación en tiempo corto (max. 5 min. + 10 min. en punto muerto)

<sup>2)</sup> variantenabhängige Bauteile / variant-dependent components / composants variante-dependantes / componenti variante-dispendenti / componentes variante-dependientes