

KDT 3.100

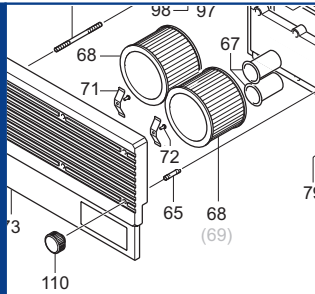

SERVICE

BECKER
D-42279 Wuppertal
www.becker-international.com

No. **D** year

type **KDT 3.100-XX** Index Variante

frequency Hz

speed min⁻¹

power required kW

inlet capacity m³/h

pressure mbar

vacuum mbar

Made in Germany

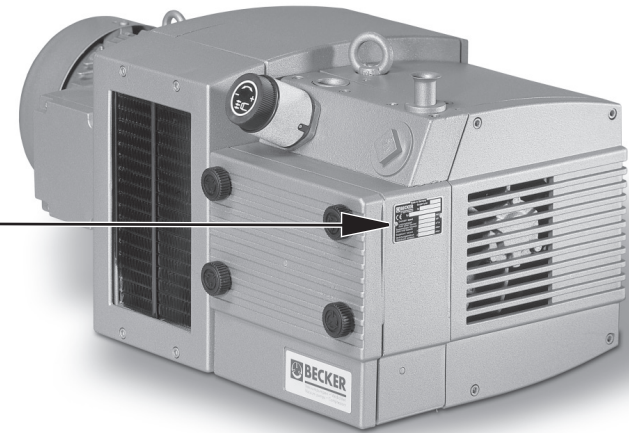

Ersatzteilliste
Spare parts list
Liste de pièces de rechange
Listino pezzi di ricambio
Lista de piezas de recambio
Lista de peças sobresselentes
Reserveonderdelenlijst
Atsarginių dalių sąrašas
Varuosad nimekirja
Rezerves daļu saraksts

Reservedelsliste
Reservdelslista
Varaosuettelotelo
Reservedelsliste
Wykaz części zamiennych
Tartalékalkatrész lista
Seznam náhradních dílů
Seznam nadomestnih delov
Zoznam náhradných dielov
Rezervni dijelovi popis

Lista pieselor de schimb
Páirteanna spártha liosta
Κατάλογος ανταλλακτικών
Yedek parça listesi
Списък на резервните части
Перечень запасных частей
スペアパーツリスト
예비 부품 목록
备用零件目录

SERVICE

www.becker-international.com

Sales and service network

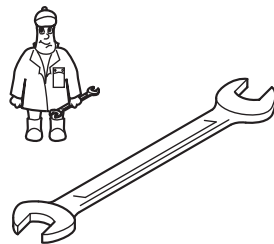

Wartung
Maintenance
Entretien
Manutenzione
Mantenimiento



Pos.	Menge ²⁾ Quantity Quantité Quantità Cantidad	Bestell-Nr. Ident No. No. Identification No. Identificazione No. de pedido	Bezeichnung Description Designation Designazione Descripción
□	1	549000 21300	Dichtungssatz, Complete set of seals, Jeu de joints, Kit di guarnizioni, Junta Completa
11	SATZ/KIT	901333 00004	Schieber, Rotor Vane, Palette, Empujador
11		901380 00004	" (KDT 3.100/0-52 + KDT 3.100/6)
11		901380 00007	" (KDT 3.100/6-29 + KDT 3.100/6-71)
11		901400 00007	" (KDT 3.100/6-71HD)
68	2	909507 00000	Filterpatrone, Filter cartridge, Cartouche Filtrante, Cartuccia filtro, Cartucho de filtro
68	1	909507 00000	" KDT 3.100/6
69	1	909587 00000	" KDT 3.100/6 - Polyester
91	1	909514 00000	Filterpatrone, Filter cartridge, Cartouche Filtrante, Cartuccia filtro, Cartucho de filtro
91	0	-	" KDT 3.100/6

²⁾ erforderliche Bestellmenge / necessary order quantity / quantité nécessaire / quantità di ordinazione necessari / cantidad necesario

KDT 3.100 Standard

Variante

KDT 3.100/XX

①

US-motor

②

B5-300

③-⑨

/0-05, /6, /0-52

/6-29, /6-71, /6-71HD, /6-54

- Korrosionsschutz

- corrosion protection

- protection contre la corrosion

- protezione anti-corrosione

- protección contra la corrosión

⑩

/0-54

- mit Abluftanschluß

- with exhaust air connection



- connexion d'évacuation d'air

- bocchettoni di scarico

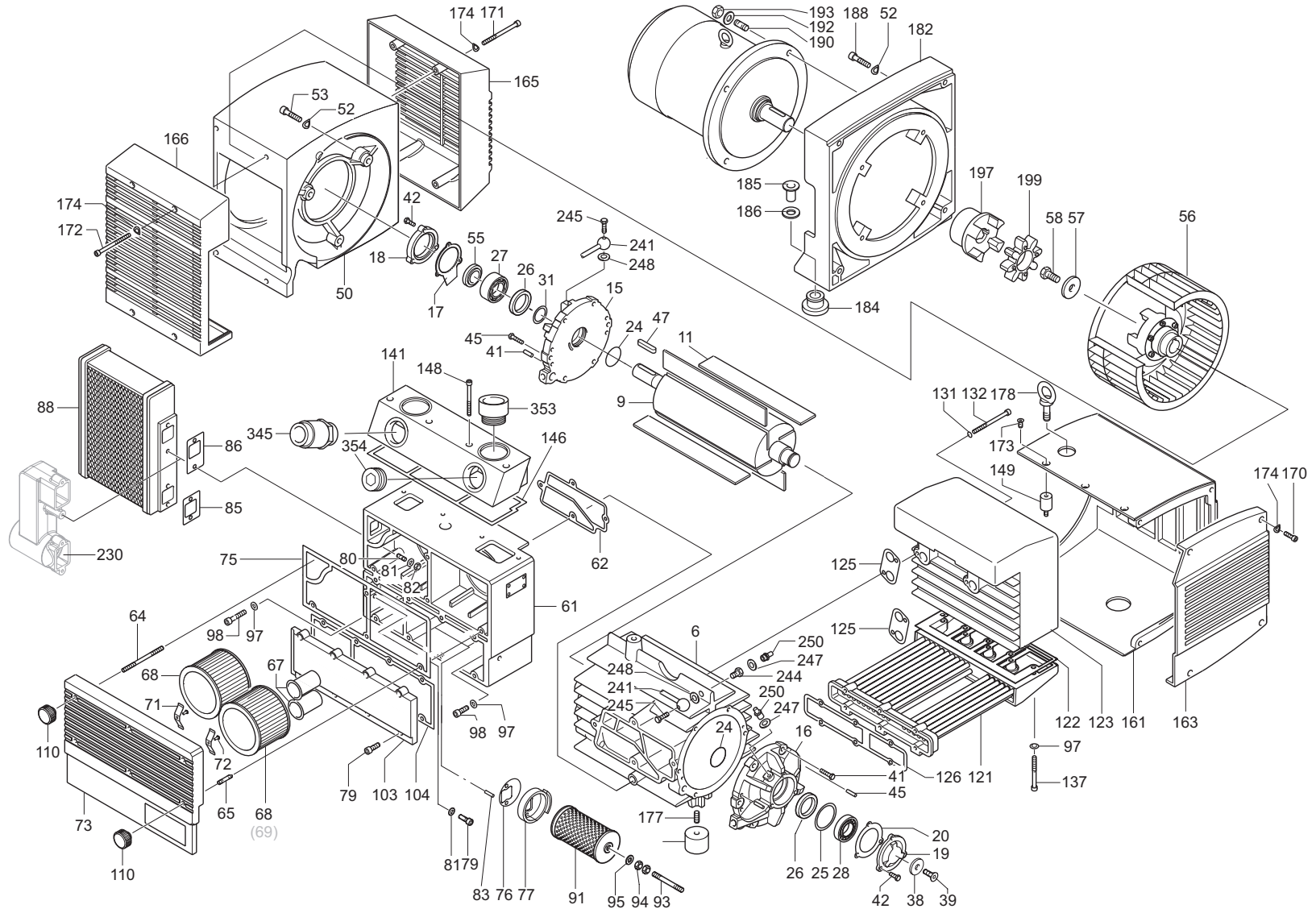
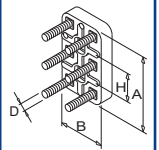
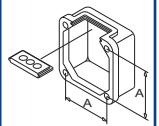
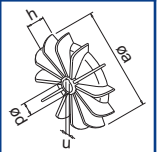
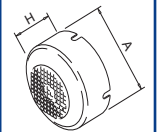
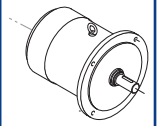
- conexión de aire de escape



SERVICE

D INDEX	Pos.	Bestell Nr.	Beschreibung	
KDT 3.100	□	549000 21300	DICHTUNGSSATZ ¹⁾	
	6	000101 21200	GEHÄUSE	
	9	020005 21200	KOLBEN	
	11	901333 00004	SCHIEBER (SATZ) ²⁾	
	15	000803 21200	SEITENDECKEL, LINKS	
	16	000701 21200	SEITENDECKEL, RECHTS	
	17	025512 21200	DICHTUNG	
	18	001100 21200	LAGERDECKEL	
	19	001000 21200	LAGERDECKEL	
	20	025513 21200	DICHTUNG	
	24	911312 00000	DICHTUNGSSCHLAUCH	
	25	917152 00000	AUSGLEICHSCHEIBE	
	26	906540 00000	WELLENDICHRING	
	27	906620 00000	WÄLZLAGER, 3205 C3 GBB20	
	28	906657 00000	WÄLZLAGER, NU 205 E GBB30	
	31	511400 10100	SATZ DISTANZSCHEIBEN	
	38	016801 21100	SPANNSCHEIBE	
	39	949807 00000	SENKSCHRAUBE	
	41	945224 00000	SECHSKANTSCHRAUBE	
	42	945222 00000	SECHSKANTSCHRAUBE	
	45	948742 00000	PASSKERBSTIFT	
	47	947736 00000	PASSFEDER	
	50	053201 21305	LATERNE	
	52	950308 00000	UNTERLEGSCHNEIBE	
	53	945331 00000	INNENSECHSKANTSCHRAUBE	
	55	011400 21200	DISTANZSCHEIBE	
	56	544500 21200	KUPPLUNGSHÄLFTE MIT VENTILATOR	
	57	949409 00000	UNTERLEGSCHNEIBE	
	58	945270 00000	WELLENENDSCHRAUBE	
	61	040102 21300	FILTERGEHÄUSE	
	62	025501 21300	DICHTUNG	
	64	951009 00000	STIFTSCHRAUBE	
	65	951003 00000	STIFTSCHRAUBE	
	67	964407 00000	SCHALLDÄMPFERROHR	
	68	909507 00000	FILTERPATRONE C 1112/2 (2x) ²⁾	
	71	009000 27000	ANPRESSFEDER	
	72	948750 00000	BLINDNIET	
	73	040201 21300	FILTERDECKEL	
	75	025518 21300	DICHTUNG	
	76	025516 21100	DICHTUNG	
	77	022802 21100	FILTERTRÄGER	
	79	945321 00000	INNENSECHSKANTSCHRAUBE	
	80	946971 00000	STIFTSCHRAUBE	
	81	947504 00000	UNTERLEGSCHNEIBE	
	82	947104 00000	SECHSKANTMUTTER	
	83	952019 00000	SPANNHÜLSE	
	85	025514 21100	DICHTUNG	
	86	025515 21100	DICHTUNG	
	88	560203 21300	KUEHLER	
	91	909514 00000	FILTERPATRONE C 718 (1x) ²⁾	
	93	903800 70000	STIFTSCHRAUBE	
	94	947105 00000	SECHSKANTMUTTER	
	95	949450 00000	U-SCHNEIBE	
	97	950304 00000	U-SCHNEIBE	
	98	945321 00000	INNENSECHSKANTSCHRAUBE	
	103	068801 21300	STAUBABSCHIEDERDECKEL	
	104	025515 21300	DICHTUNG	
	110	921500 50000	HANDGRIFF	
	121	560204 21300	KÜHLER	

D INDEX	Pos.	Bestell Nr.	Beschreibung	
	122	025506 21300	DICHTUNG	
	123	066802 21300	DRUCKANSCHLUSSKASTEN	
	125	025504 21300	DICHTUNG	
	126	025514 21300	DICHTUNG	
	131	948021 00000	DICHRING	
	132	945374 00020	INNENSECHSKANTSCHRAUBE	
	137	945322 00000	INNENSECHSKANTSCHRAUBE	
	141	016604 21300	ANSCHLUSSLEISTE	
	146	025507 21300	DICHTUNG	
	148	945364 00000	INNENSECHSKANTSCHRAUBE	
	149	741310 30000	GUMMIPUFFER	
	161	918300 21300	ABDECKHAUBE	
	163	920800 21300	LUFTLEITRING	
	165	960700 21300	LÜFTERHAUBE	
	166	960701 21300	LÜFTERHAUBE	
	170	945321 00010	INNENSECHSKANTSCHRAUBE	
	171	945371 00010	INNENSECHSKANTSCHRAUBE	
	172	945372 00010	INNENSECHSKANTSCHRAUBE	
	173	949806 00000	SENKSCHRAUBE	
	174	951703 00000	FEDERSCHNEIBE	
	176	741302 00000	GUMMIPUFFER	
	177	945634 00000	GEWINDESTIFT	
	178	948802 00000	RINGSCHRAUBE	
	182	014902 21305	ZWISCHENFLANSCH (B5-250)	
	184	951916 00000	KABELTÜLLE	
	185	948772 00000	ROHRNIETE	
	186	947508 00000	UNTERLEGSCHNEIBE	
	188	945335 00000	INNENSECHSKANTSCHRAUBE	
	190	951018 00000	STIFTSCHRAUBE (B5-250)	
	192	947506 00000	UNTERLEGSCHNEIBE	
	193	947106 00000	SECHSKANTMUTTER	
	197	902108 00000	KUPPLUNGSHÄLFTE (MOT) (B5-250)	
	199	902210 00000	KUPPLUNGSSCHNEIBE	
	241	012200 21200	LEITUNG	
	244	912300 00000	ANSCHLUSSSCHRAUBE	
	245	009400 19000	KUGELSTÜCKSCHRAUBE	
	247	948074 00000	DICHRING	
	248	948021 00000	DICHRING	
	250	949002 00000	SCHMIERNIPPEL	
	345	728000 99622	DRUCKREGULIERVENTIL / 0,6 BAR	
	345	728001 99622	DRUCKREGULIERVENTIL / 1,0 BAR	
	345	728002 99622	DRUCKREGULIERVENTIL / 2,0 BAR	
	345	728003 99622	DRUCKREGULIERVENTIL / 0,3 BAR	
	353	953111 00000	SCHALLDÄMPFERDÜSE	
	354	912805 00000	VERSCHLUSSSTOPFEN	
		743303 00000	SPEZIALFETT (FETTPRESSE, 50g)	

¹⁾ Dichtungssatz - 54900021300 - Pos.: 17, 20, 24, 62, 75, 76, 85, 86, 104, 122, 125, 126, 146
²⁾ erforderliche Bestellmenge / Wartung

D INDEX	Pos.	Ident No.	Description	
KDT 3.100	□	549000 21300	SET OF SEALS ¹⁾	
	6	000101 21200	PUMP BODY	
	9	020005 21200	ROTOR	
	11	901333 00004	CARBON VANES (KIT) ²⁾	
	15	000803 21200	LID, LEFT	
	16	000701 21200	LID, RIGHT	
	17	025512 21200	GASKET	
	18	001100 21200	BEARING COVER, 3205 C3 GBB20	
	19	001000 21200	BEARING COVER, NU 205 E GBB30	
	20	025513 21200	GASKET	
	24	911312 00000	SEAL	
	25	917152 00000	COMPENSATING DISC	
	26	906540 00000	SHAFT-SEALING RING	
	27	906620 00000	BALL BEARING	
	28	906657 00000	BALL BEARING	
	31	511400 10100	SET DISTANCE DISC	
	38	016801 21100	CLAMPING DISC	
	39	949807 00000	SCREW	
	41	945224 00000	HEX-HEAD SCREW	
	42	945222 00000	HEX-HEAD SCREW	
	45	948742 00000	STRAIGHT PIN	
	47	947736 00000	KEY	
	50	053201 21305	CONNECTION FLANGE	
	52	950308 00000	WASHER	
	53	945331 00000	SOCKET HEAD SCREW	
	55	011400 21200	DISTANCE DISC	
	56	544500 21200	COUPLING WITH FAN	
	57	949409 00000	WASHER	
	58	945270 00000	SHAFT END BOLD	
	61	040102 21300	FILTER HOUSING	
	62	025501 21300	GASKET	
	64	951009 00000	STUD	
	65	951003 00000	STUD	
	67	964407 00000	SILENCER TUBE	
	68	909507 00000	FILTER CARTRIDGE C 1112/2 (2x) ²⁾	
	71	009000 27000	LEAF SPRING	
	72	948750 00000	BLIND RIVET	
	73	040201 21300	FILTER COVER	
	75	025518 21300	GASKET	
	76	025516 21100	GASKET	
	77	022802 21100	FILTER HOLDER	
	79	945321 00000	SOCKET HEAD SCREW	
	80	946971 00000	STUD	
	81	947504 00000	WASHER	
	82	947104 00000	HEX.NUT	
	83	952019 00000	LOCATING PEG	
	85	025514 21100	GASKET	
	86	025515 21100	GASKET	
	88	560203 21300	COOLER	
	91	909514 00000	FILTER CARTRIDGE C 718 (1x) ²⁾	
	93	903800 70000	STUD	
	94	947105 00000	HEX.NUT	
	95	949450 00000	WASHER	
	97	950304 00000	WASHER	
	98	945321 00000	SOCKET HEAD SCREW	
	103	068801 21300	DUST SEPARATOR COVER	
	104	025515 21300	GASKET	
	110	921500 50000	HANDLE	
	121	560204 21300	COOLER	

D INDEX	Pos.	Ident No.	Description	
	122	025506 21300	GASKET	
	123	066802 21300	PRESSURE CONNECTION BOX	
	125	025504 21300	GASKET	
	126	025514 21300	GASKET	
	131	948021 00000	SEALING RING	
	132	945374 00020	SOCKET HEAD SCREW	
	137	945322 00000	SOCKET HEAD SCREW	
	141	016604 21300	CONNECTING PIECE	
	146	025507 21300	GASKET	
	148	945364 00000	SOCKET HEAD SCREW	
	149	741310 30000	RUBBER BUFFER	
	161	918300 21300	COVERING HOOD	
	163	920800 21300	AIR GUIDE COVER RING	
	165	960700 21300	VENTILATOR HOOD	
	166	960701 21300	VENTILATOR HOOD	
	170	945321 00010	SOCKET HEAD SCREW	
	171	945371 00010	SOCKET HEAD SCREW	
	172	945372 00010	SOCKET HEAD SCREW	
	173	949806 00000	COUNTERSUNK SCREW	
	174	951703 00000	SPRING DISC	
	176	741302 00000	RUBBER BUFFER	
	177	945634 00000	THREADED PIN	
	178	948802 00000	RING SCREW	
	182	014902 21305	FLANGE (B5-250)	
	184	951916 00000	RUBBER BUSHING	
	185	948772 00000	PIPE RIVET	
	186	947508 00000	WASHER	
	188	945335 00000	SOCKET HEAD SCREW	
	190	951018 00000	STUD (B5-250)	
	192	947506 00000	WASHER	
	193	947106 00000	HEX.NUT	
	197	902108 00000	COUPLING (B5-250)	
	199	902210 00000	COUPLING DISC	
	241	012200 21200	OIL-PIPE	
	244	912300 00000	CONNECTING SCREW	
	245	009400 19000	HOLLOW HOLDING SCREW	
	247	948074 00000	SEALING RING	
	248	948021 00000	SEALING RING	
	250	949002 00000	GREASE NIPPLE	
	345	728000 99622	PRESSURE REGULATION VALVE / 8,7 PSI	
	345	728001 99622	PRESSURE REGULATION VALVE / 14,5 PSI	
	345	728002 99622	PRESSURE REGULATING VALVE / 29 PSI	
	345	728003 99622	PRESSURE REGULATING VALVE / 4,35 PSI	
	353	953111 00000	NOZZLE	
	354	912805 00000	PLUG	
		743303 00000	 SPECIAL GREASE (GREASE PRESS, 50g)	

¹⁾ Set of seals - 54900021300 - Pos.: 17, 20, 24, 62, 75, 76, 85, 86, 104, 122, 125, 126, 146
²⁾ necessary order quantity / maintenance

D INDICE	Pos.	No. Identification	Designation	FR	
KDT 3.100	■	549000 21300	JEU DE JOINTS ¹⁾		
	6	000101 21200	CORP DE POMPE		
	9	020005 21200	PISTON		
	11	901333 00004	PALETTE DE CHARBON (KIT) ²⁾		
	15	000803 21200	COUVERCLE A GAUCHE		
	16	000701 21200	COUVERCLE A DROITE		
	17	025512 21200	JOINT		
	18	001100 21200	COUVERCLE DE ROULEMENTE		
	19	001000 21200	COUVERCLE DE ROULEMENTE		
	20	025513 21200	JOINT		
	24	911312 00000	JOINT		
	25	917152 00000	DISQUE DE COMPENSATION		
	26	906540 00000	BAGUE D'ETANCHEITE P.L'AXE		
	27	906620 00000	ROULEMENT A BILLES, 3205 C3 GBB20		
	28	906657 00000	ROULEMENT A BILLES, NU 205 E GBB30		
	31	511400 10100	JEU DISQUE DE TOLERANCE		
	38	016801 21100	DISQUE DE SERRAGE		
	39	949807 00000	VIS		
	41	945224 00000	VIS HEXAGONALE		
	42	945222 00000	VIS HEXAGONALE		
	45	948742 00000	GOUPILLE CYLINDRIQUE		
47	947736 00000	CLAVETTE			
50	053201 21305	BRIDE DE RACCORDEMENT			
52	950308 00000	RONDELLE			
53	945331 00000	VIS HEXAGONALE INTERNE			
55	011400 21200	DISQUE AJUSTAGE			
56	544500 21200	ACCOUPLLEMENT AVEC VENTILATEUR			
57	949409 00000	RONDELLE			
58	945270 00000	VIS BOUT D'ARBRE			
61	040102 21300	BOITE POUR FILTRE			
62	025501 21300	JOINT			
64	951009 00000	PRISONNIER			
65	951003 00000	PRISONNIER			
67	964407 00000	TUBE SILENCIEUX			
68	909507 00000	CARTOUCHE FILTRANTE C 1112/2 (2x) ²⁾			
71	009000 27000	RESSORT-JAME			
72	948750 00000	RIVET AVEUGLIE			
73	040201 21300	COUVERCLE DE FILTRE			
75	025518 21300	JOINT			
76	025516 21100	JOINT			
77	022802 21100	SUPPORT FILTRE			
79	945321 00000	VIS HEXAGONALE INTERNE			
80	946971 00000	PRISONNIER			
81	947504 00000	RONDELLE			
82	947104 00000	ECROU A 6 PANS			
83	952019 00000	DOUILLE DE ETRAGE			
85	025514 21100	JOINT			
86	025515 21100	JOINT			
88	560203 21300	REFROIDISSEUR			
91	909514 00000	CARTOUCHE FILTRANTE C 718 (1x) ²⁾			
93	903800 70000	PRISONNIER			
94	947105 00000	ECROU A 6 PANS			
95	949450 00000	RONDELLE			
97	950304 00000	RONDELLE			
98	945321 00000	VIS HEXAGONALE INTERNE			
103	068801 21300	COUVERCLE			
104	025515 21300	JOINT			
110	921500 50000	POIGNEE			
121	560204 21300	REFROIDISSEUR			

D INDICE	Pos.	No. Identification	Designation	FR	
	122	025506 21300	JOINT		
	123	066802 21300	BOITIER DE RACCORD DE REFOULEMENT		
	125	025504 21300	JOINT		
	126	025514 21300	JOINT		
	131	948021 00000	JOINT		
	132	945374 00020	VIS HEXAGONALE INTERNE		
	137	945322 00000	VIS HEXAGONALE INTERNE		
	141	016604 21300	PIECE RACCORD		
	146	025507 21300	JOINT		
	148	945364 00000	VIS HEXAGONALE INTERNE		
	149	741310 30000	AMORTISSEUR EN CAOUTCHOUC		
	161	918300 21300	CARTER		
	163	920800 21300	CAPOT DE CANALISATION DE L'AIR		
	165	960700 21300	CARTER DE VENTILATEUR		
	166	960701 21300	CARTER DE VENTILATEUR		
	170	945321 00010	VIS HEXAGONALE INTERNE		
	171	945371 00010	VIS HEXAGONALE INTERNE		
	172	945372 00010	VIS HEXAGONALE INTERNE		
	173	949806 00000	VIS A TÊTE NOYÉE		
	174	951703 00000	DISQUE DE RESSORT		
	176	741302 00000	AMORTISSEUR EN CAOUTCHOUC		
	177	945634 00000	GOUPILLE FILETEE		
	178	948802 00000	PITON		
	182	014902 21305	BRIDE (B5-250)		
	184	951916 00000	PROTECTION EN CAOUTCHOUC		
	185	948772 00000	RIVET TUBE		
	186	947508 00000	RONDELLE		
	188	945335 00000	VIS HEXAGONALE INTERNE		
	190	951018 00000	PRISONNIER (B5-250)		
	192	947506 00000	RONDELLE		
	193	947106 00000	ECROU A 6 PANS		
	197	902108 00000	ACCOUPLLEMENT (B5-250)		
	199	902210 00000	DISQUE D'ACCOUPLLEMENT		
	241	012200 21200	TUYEAU DE GRAISSAGE		
	244	912300 00000	VIS DE RACCORD		
	245	009400 19000	VIS CREUSE DE FIXATION		
	247	948074 00000	JOINT		
	248	948021 00000	JOINT		
	250	949002 00000	GRAISSEUR		
	345	728000 99622	SOUPAPE REGLAGE PRESSION / 0,6 BAR		
	345	728001 99622	SOUPAPE REGLAGE PRESSION / 1,0 BAR		
	345	728002 99622	SOUPAPE REGLAGE PRESSION / 2,0 BAR		
	345	728003 99622	SOUPAPE REGLAGE PRESSION / 0,3 BAR		
	353	953111 00000	BUSE		
	354	912805 00000	BOUCHON		
		743303 00000	GRAISSE SPÉCIFIQUE (POMPE À GRAISSE, 50g)		

¹⁾ Jeu de joints - 54900021300 - Pos.: 17, 20, 24, 62, 75, 76, 85, 86, 104, 122, 125, 126, 146

²⁾ quantité nécessaire / entretien

D INDICE	Pos.	No. Identificazione	Designazione	IT	
KDT 3.100	■	549000 21300	SERIE DI GUARNIZIONE ¹⁾		
	6	000101 21200	CARCASSA		
	9	020005 21200	ROTORE		
	11	901333 00004	PALETTE DI CHARBONE (KIT) ²⁾		
	15	000803 21200	COPERCHIO SINISTRA		
	16	000701 21200	COPERCHIO DESTRA		
	17	025512 21200	GUARNIZIONE		
	18	001100 21200	COPERCHIO CUSCINETTO		
	19	001000 21200	COPERCHIO CUSCINETTO		
	20	025513 21200	GUARNIZIONE		
	24	911312 00000	GUARNIZIONE		
	25	917152 00000	DISCO COMPENSATORE		
	26	906540 00000	GUARNIZIONE PER L'ALBERO		
	27	906620 00000	CUSCINETTO A SFERA, 3205 C3 GBB20		
	28	906657 00000	CUSCINETTO A SFERA, NU 205 E GBB30		
	31	511400 10100	SERIE DISCO GIUOCO		
	38	016801 21100	DISCO DI FISSAGGIO		
	39	949807 00000	VITE		
	41	945224 00000	VITE ESAGONALE		
	42	945222 00000	VITE ESAGONALE		
	45	948742 00000	PERNO		
	47	947736 00000	CHIAVETTA		
	50	053201 21305	FLANGIA DI RACCORDE		
	52	950308 00000	RONDELLA		
	53	945331 00000	VITE ESAGONALE INTERNA		
	55	011400 21200	DISCO GIUOCO		
	56	544500 21200	GIUNTO CON VENTILATORE		
	57	949409 00000	RONDELLA		
	58	945270 00000	VITE DI CHIUSURA ALBERO		
	61	040102 21300	CONTENITORE FILTRO		
	62	025501 21300	GUARNIZIONE		
	64	951009 00000	L'ASTA A VITE		
	65	951003 00000	L'ASTA A VITE		
	67	964407 00000	TUBO SILENZIATORE		
	68	909507 00000	CARTUCCIA FILTRO C 1112/2 (2x) ²⁾		
	71	009000 27000	MOLLA		
	72	948750 00000	RIVETTO CIECO		
	73	040201 21300	COPERCHIO FILTRO		
	75	025518 21300	GUARNIZIONE		
	76	025516 21100	GUARNIZIONE		
	77	022802 21100	SUPPORTO FILTRO		
	79	945321 00000	VITE ESAGONALE INTERNA		
	80	946971 00000	L'ASTA A VITE		
	81	947504 00000	RONDELLA		
	82	947104 00000	DADO ESAGONALE		
	83	952019 00000	SPINE DI RISCONTRO		
	85	025514 21100	GUARNIZIONE		
	86	025515 21100	GUARNIZIONE		
	88	560203 21300	RAFFREDDATORE		
	91	909514 00000	CARTUCCIA FILTRO C 718 (1x) ²⁾		
	93	903800 70000	L'ASTA A VITE		
	94	947105 00000	DADO ESAGONALE		
	95	949450 00000	RONDELLA		
	97	950304 00000	RONDELLA		
	98	945321 00000	VITE ESAGONALE INTERNA		
	103	068801 21300	COPERCHIO		
	104	025515 21300	GUARNIZIONI		
	110	921500 50000	MANETTA		
	121	560204 21300	RAFFREDDATORE		

D INDICE	Pos.	No. Identificazione	Designazione	IT	
	122	025506 21300	GUARNIZIONE		
	123	066802 21300	SCATOLA DI RACCORDO DI MANDATA		
	125	025504 21300	GUARNIZIONE		
	126	025514 21300	GUARNIZIONI		
	131	948021 00000	ANELLO GUARNIZIONE		
	132	945374 00020	VITE ESAGONALE INTERNA		
	137	945322 00000	VITE ESAGONALE INTERNA		
	141	016604 21300	PEZZI RACCORDI		
	146	025507 21300	GUARNIZIONE		
	148	945364 00000	VITE ESAGONALE INTERNA		
	149	741310 30000	AMMORTIZZATORE IN GOMMA		
	161	918300 21300	CARTER		
	163	920800 21300	CAPPOTTA DEL CONDOTTA ARIA		
	165	960700 21300	CARTER VENTILATORE		
	166	960701 21300	CARTER VENTILATORE		
	170	945321 00010	VITE ESAGONALE INTERNA		
	171	945371 00010	VITE ESAGONALE INTERNA		
	172	945372 00010	VITE ESAGONALE INTERNA		
	173	949806 00000	VITE A TESTA SVASATA		
	174	951703 00000	DISCO A MOLLA		
	176	741302 00000	AMMORTIZZATORE IN GOMMA		
	177	945634 00000	SPINA FILETTATURA		
	178	948802 00000	GANCIO		
	182	014902 21305	FLANGIA (B5-250)		
	184	951916 00000	PROTEZIONE IN GOMMA		
	185	948772 00000	CHIODO TUBOLARE		
	186	947508 00000	RONDELLA		
	188	945335 00000	VITE ESAGONALE INTERNA		
	190	951018 00000	L'ASTA A VITE (B5-250)		
	192	947506 00000	RONDELLA		
	193	947106 00000	DADO ESAGONALE		
	197	902108 00000	GIUNTO (B5-250)		
	199	902210 00000	DISCO GIUNTO		
	241	012200 21200	CONDOTTO		
	244	912300 00000	ATTACO FILETTATO		
	245	009400 19000	VITE PASSAGGIO OLIO		
	247	948074 00000	ANELLO GUARNIZIONE		
	248	948021 00000	ANELLO GUARNIZIONE		
	250	949002 00000	RACCORDO DI LUBRIFICAZIONE		
	345	728000 99622	VALVOLA REGOLAZIONE PRESSIONE / 0,6 BAR		
	345	728001 99622	VALVOLA REGOLAZIONE PRESSIONE / 1,0 BAR		
	345	728002 99622	VALVOLA REGOLAZIONE PRESSIONE / 2,0 BAR		
	345	728003 99622	VALVOLA REGOLAZIONE PRESSIONE / 0,3 BAR		
	353	953111 00000	UGGELLO		
	354	912805 00000	TAPPO DI CHIUSURA		
		743303 00000	GRASSO SPECIALE (INGRASSATORE A PISTOLA, 50g)		

¹⁾ Serie di guarnizione - 54900021300 - Pos.: 17, 20, 24, 62, 75, 76, 85, 86, 104, 122, 125, 126, 146

²⁾ quantità di ordinazione necessari / manutenzione

D INDICE	Pos.	No. De pedido	Descripción	ES	
				ES	
KDT 3.100	■	549000 21300	JUNTA COMPLETA ¹⁾		
	6	000101 21200	CARCASA		
	9	020005 21200	ÉMBOLO, ACABADO		
	11	901333 00004	EMPUJADOR (KIT) ²⁾		
	15	000803 21200	TAPA LATERAL		
	16	000701 21200	TAPA LATERAL DERECHA		
	17	025512 21200	JUNTA		
	18	001100 21200	TAPA DE COJINETE		
	19	001000 21200	TAPA DE COJINETE		
	20	025513 21200	JUNTA		
24	911312 00000	MANGUERA DE JUNTA			
25	917152 00000	ARANDELA DE COMPENSACIÓN			
26	906540 00000	ANILLO DE JUNTA DE ÁRBOL			
27	906620 00000	COJINETE DE RODAMIENTO, 3205 C3 GBB20			
28	906657 00000	COJINETE DE RODAMIENTO, NU 205 E GBB30			
31	511400 10100	JUEGO DE ARANDELAS DISTANCIADORAS			
38	016801 21100	ARANDELA TENSORA			
39	949807 00000	TORNILLO AVELLANADO			
41	945224 00000	TORNILLO DE CABEZA HEXAGONAL			
42	945222 00000	TORNILLO DE CABEZA HEXAGONAL			
45	948742 00000	PASADOR ENTALLADO DE AJUSTE			
47	947736 00000	LENGÜETA DE AJUSTE			
50	053201 21305	FAROL			
52	950308 00000	ARANDELA			
53	945331 00000	TORNILLO HEXAGONAL INTERIOR			
55	011400 21200	ARANDELA DISTANCIADORA			
56	544500 21200	MITAD DE ACOPLAMIENTO CON VENTILADOR			
57	949409 00000	ARANDELA			
58	945270 00000	TORNILLO TERMINAL DE ÁRBOL			
61	040102 21300	CARCASA DE FILTRO			
62	025501 21300	JUNTA			
64	951009 00000	ESPÁRRAGO			
65	951003 00000	ESPÁRRAGO			
67	964407 00000	TUBO DE SILENCIADOR			
68	909507 00000	CARTUCHO DE FILTRO C 1112/2 (2x) ²⁾			
71	009000 27000	MUELLE DE PRESIÓN			
72	948750 00000	REMACHE CIEGO			
73	040201 21300	TAPA DE FILTRO			
75	025518 21300	JUNTA			
76	025516 21100	JUNTA			
77	022802 21100	SOPORTE DE FILTRO			
79	945321 00000	TORNILLO HEXAGONAL INTERIOR			
80	946971 00000	ESPÁRRAGO			
81	947504 00000	ARANDELA			
82	947104 00000	TUERCA HEXAGONAL			
83	952019 00000	CASQUILLO TENSOR			
85	025514 21100	JUNTA			
86	025515 21100	JUNTA			
88	560203 21300	REFRIGERADOR			
91	909514 00000	CARTUCHO DE FILTRO C 718 (1x) ²⁾			
93	903800 70000	ESPÁRRAGO			
94	947105 00000	TUERCA HEXAGONAL			
95	949450 00000	ARANDELA			
97	950304 00000	ARANDELA			
98	945321 00000	TORNILLO HEXAGONAL INTERIOR			
103	068801 21300	TAPA DE SEPARADOR DE POLVO			
104	025515 21300	JUNTA			
110	921500 50000	EMPUÑADURA			
121	560204 21300	REFRIGERADOR			

D INDICE	Pos.	No. De pedido	Descripción	ES	
				ES	
	122	025506 21300	JUNTA		
	123	066802 21300	CAJA DE EMPALME DE PRESIÓN		
	125	025504 21300	JUNTA		
	126	025514 21300	JUNTA		
	131	948021 00000	ANILLO DE JUNTA		
	132	945374 00020	TORNILLO HEXAGONAL INTERIOR		
	137	945322 00000	TORNILLO HEXAGONAL INTERIOR		
	141	016604 21300	PIEZA DE EMPALME		
	146	025507 21300	JUNTA		
	148	945364 00000	TORNILLO HEXAGONAL INTERIOR		
	149	741310 30000	AMORTIGUADOR DE GOMA		
	161	918300 21300	CAPERUZA DE RECUBRIMIENTO		
	163	920800 21300	CAPERUZA CONDUCTOR DE AIRE		
	165	960700 21300	CAPERUZA DE VENTILADOR		
	166	960701 21300	CAPERUZA DE VENTILADOR		
	170	945321 00010	TORNILLO HEXAGONAL INTERIOR		
	171	945371 00010	TORNILLO HEXAGONAL INTERIOR		
	172	945372 00010	TORNILLO HEXAGONAL INTERIOR		
	173	949806 00000	TORNILLO AVELLANADO		
	174	951703 00000	ARANDELA ELÁSTICA		
	176	741302 00000	AMORTIGUADOR DE GOMA		
	177	945634 00000	VARILLA ROSCADA		
	178	948802 00000	TORNILLO DE CÁNCAMO		
	182	014902 21305	BRIDA INTERMEDIA (B5-250)		
	184	951916 00000	BOQUILLA DE CABLE		
	185	948772 00000	REMACHE TUBULAR		
	186	947508 00000	ARANDELA		
	188	945335 00000	TORNILLO HEXAGONAL INTERIOR		
	190	951018 00000	ESPÁRRAGO (B5-250)		
	192	947506 00000	ARANDELA		
	193	947106 00000	TUERCA HEXAGONAL		
	197	902108 00000	MITAD DE ACOPLAMIENTO (MOT) (B5-250)		
	199	902210 00000	DISCO DE ACOPLAMIENTO		
	241	012200 21200	CONDUCTO		
	244	912300 00000	TORNILLO DE EMPALME		
	245	009400 19000	TORNILLO DE PIEZA ESFÉRICA		
	247	948074 00000	ANILLO DE JUNTA		
	248	948021 00000	ANILLO DE JUNTA		
	250	949002 00000	BOQUILLA DE TOLVA DE LUBRICACIÓN		
	345	728000 99622	VÁLVULA REGULADORA DE PRESIÓN / 0,6 BAR		
	345	728001 99622	VÁLVULA REGULADORA DE PRESIÓN / 1,0 BAR		
	345	728002 99622	VÁLVULA REGULADORA DE PRESIÓN / 2,0 BAR		
	345	728003 99622	VÁLVULA REGULADORA DE PRESIÓN / 0,3 BAR		
	353	953111 00000	TOBERA DE SILENCIADOR		
	354	912805 00000	TAPÓN DE DESGASTE		
		743303 00000	GRASA ESPECIAL (PISTOLA DE GRASA, 50g)		

¹⁾ Junta completa - 54900021300 - Pos.: 17, 20, 24, 62, 75, 76, 85, 86, 104, 122, 125, 126, 146

²⁾ cantidad necesario / mantenimiento

KDT 3.100	Variante 	Pos. ²⁾	Bestell Nr. / Ident No. / No. Identification / No. Identificazione / No. De pedido		Beschreibung / Description / Designation / Designazione / Desripcion
①	US-motor	182	037900 10400	014902-21305	ZWISCHENFLANSCH / INTERMEDIATE FLANGE / BRIDE INTERMEDIAIRE / FLANGE INTERMEDIA / BRIDA INTERMEDIA
②	B5-300	182	014903 21305	014902-21305	ZWISCHENFLANSCH / INTERMEDIATE FLANGE / BRIDE INTERMEDIAIRE / FLANGE INTERMEDIA / BRIDA INTERMEDIA
		190	951022 00000	951018-00000	STIFTSCHRAUBE / STUD / GOUJON PRISONNIER / VITE PRIGIONIERA / PRISIONERO CON ROSCA
		197	902100 21900	902108-00000	MOTORKUPPLUNG / COUPLING / ACCOUPLEMENT / GIUNTO / ACOPLAMIENTO
③	/0-05 - Korrosionsschutz - corrosion protection - protection contre la corrosion - protezione anti-corrosione - protección contra la corrosión	9	020006 21200	020005-21200	KOLBEN / ROTOR / PISTON / ROTORE / ÉMBOLO
④	/0-52 - Korrosionsschutz - corrosion protection - protection contre la corrosion - protezione anti-corrosione - protección contra la corrosión	9	020006 21200	020005-21200	KOLBEN / ROTOR / PISTON / ROTORE / ÉMBOLO
		11	901380 00004	901333-00004	SATZ (KIT) SCHIEBER / VANES / PALETTE / PALETTE / EMPUJADOR
		345		72800X-99622	DRUCKREGULIERVENTIL / PRESSURE REGULATING VALVE / SOUPAPE REGLAGE PRESSION / VALVOLA REGOLAZIONE PRESSIONE / VÁLVULA REGULADORA DE PRESIÓN
		352	964419 00000		SCHALLDÄMPFERROHR / SILENCER TUBE / TUBE SILENCIEUX / TUBO SILENZIATORE / TUBO SILENCIADOR
		353	921012 00000	953111-00000	GEWINDERING / THREADED RING / BAGUE FILETÉE / ANELLO FILETTATO / ANILLO ROSCADO
403	734000 02000		DRUCKREGULIERVENTIL 2,2 BAR / PRESSURE REGULATING VALVE 32 PSI / SOUPAPE REGLAGE PRESSION 2,2 BAR / VALVOLA REGOLAZIONE PRESSIONE 2,2 BAR / VÁLVULA REGULADORA DE PRESIÓN 2,2 BAR		
⑤	/6 - Korrosionsschutz - corrosion protection - protection contre la corrosion - protezione anti-corrosione - protección contra la corrosión	6	000111 21200	000101-21200	GEHÄUSE / PUMP BODY / CORP DE POMPE / CARCASSA / CARCASA
		9	020011 21200	020005-21200	KOLBEN / ROTOR / PISTON / ROTORE / ÉMBOLO
		11	901380 00004	901333-00004	SATZ (KIT) SCHIEBER / VANES / PALETTE / PALETTE / EMPUJADOR
		15	000811 21200	000803-21200	SEITENDECKEL / LID LATERAL / COUVERCLE LATÉRAL / COPERCHIO LATERALE / TAPA LATERAL
		16	000711 21200	000701-21200	SEITENDECKEL / LID LATERAL / COUVERCLE LATÉRAL / COPERCHIO LATERALE / TAPA LATERAL
		68		909507-00000	FILTERPATRONE / FILTER CARTRIDGE / CARTOUCHE FILTRE / CARTUCCIA FILTRO / CARTUCHO DE FILTRO
		69	909587 00000		FILTERPATRONE (1x POLYESTER) / FILTER CARTRIDGE / CARTOUCHE FILTRE / CARTUCCIA FILTRO / CARTUCHO DE FILTRO
		76		025516-21100	DICHTUNG / GASKET / JOINT / GUARNIZIONE / JUNTA
		77		022802-21100	FILTERTRÄGER / FILTER HOLDER / SUPPORT FILTRE / SUPPORTO FILTRO / SOPORTO DE FILTRO
		83		952019-00000	SPANNHÜLSE / FIXING SLEEVE / MANCHON DE FIXATION / MANICOTTODI FISSAZIANO / MANGUITO DE FIJACIÓN
		91		909514-00000	FILTERPATRONE / FILTER CARTRIDGE / CARTOUCHE FILTRE / CARTUCCIA FILTRO / CARTUCHO DE FILTRO
		93	945634 00000	903800-70000	STIFTSCHRAUBE / STUD / PRISONNIER / L'ASTA A VITE / ESPÁRRAGO
		94		947105-00000	SECHSKANTMUTTER / HEX.NUT / ECROU A 6PANS / DADO ESAGONALE / TUERCA HEXAGONAL
95		949450-00000	UNTERLEGSSCHEIBE / WASHER / RONDELLE / RONDELLA / ARANDELA		







²⁾ variantenabhängige Bauteile / variant-dependent components / composants variante-dependantes / componenti variante-dispendenti / componentes variante-dependientes

KDT 3.100	Variante 	Pos. ²⁾	Bestell Nr. / Ident No. / No. Identification / No. Identificazione / No. De pedido		Beschreibung / Description / Designation / Designazione / Desripcion
⑥ /6-54 - Korrosionsschutz - corrosion protection - protection contre la corrosion - protezione anti-corrosione - protección contra la corrosión		6	000111 21200	000101-21200	GEHÄUSE / PUMP BODY / CORP DE POMPE / CARCASSA / CARCASA
		9	020011 21200	020005-21200	KOLBEN / ROTOR / PISTON / ROTORE / ÉMBOLO
		11	901380 00004	904333-00004	SATZ (KIT) SCHIEBER / VANES / PALETTE / PALETTE / EMPUJADOR
		15	000811 21200	000803-21200	SEITENDECKEL / LID LATERAL / COUVERCLE LATÉRAL / COPERCHIO LATERALE / TAPA LATERAL
		16	000711 21200	000701-21200	SEITENDECKEL / LID LATERAL / COUVERCLE LATÉRAL / COPERCHIO LATERALE / TAPA LATERAL
		68		909507-00000	FILTERPATRONE / FILTER CARTRIDGE / CARTOUCHE FILTRE / CARTUCCIA FILTRO / CARTUCHO DE FILTRO
		69	909587 00000		FILTERPATRONE (1x POLYESTER) / FILTER CARTRIDGE / CARTOUCHE FILTRE / CARTUCCIA FILTRO / CARTUCHO DE FILTRO
		76		025516-21100	DICHTUNG / GASKET / JOINT / GUARNIZIONE / JUNTA
		77		022802-21100	FILTERTRÄGER / FILTER HOLDER / SUPPORT FILTRE / SUPPORTO FILTRO / SOPORTE DE FILTRO
		83		952019-00000	SPANNHÜLSE / LOCATING PEG / DOUILLE DE ETRAGE / SPINE DI RISCNTRO / CASQUILLO TENSOR
		88		560203-21300	KÜHLER / COOLER / REFROIDISSEUR / RAFFREDDATORE / REFRIGERADOR
		91		909514-00000	FILTERPATRONE / FILTER CARTRIDGE / CARTOUCHE FILTRANTE / CARTUCCIA FILTRO / CARTUCHO DE FILTRO
		93		903800-70000	STIFTSCHRAUBE / STUD / GOUJON PRISONNIER / VITE PRIGIONIERA / PRISIONERO CON ROSCA
		94		947105-00000	SECHSKANTMUTTER / HEX.NUT / ECROU A 6 PANS / DADO ESAGONALE / TUERCA HEXAGONAL
		95		949450-00000	U-SCHEIBE / WASHER / RONDELLE / RONDELLA / ARANDELA
	230	019901 21100		UMLENKSTÜCK / RETURN PIECE / PIECE DE RETOUR / PEZZO INVERSIONE / PIEZA DE DESVIACIÓN	
⑦ /6-29 - Korrosionsschutz - corrosion protection - protection contre la corrosion - protezione anti-corrosione - protección contra la corrosión		6	000111 21200	000101-21200	GEHÄUSE / PUMP BODY / CORP DE POMPE / CARCASSA / CARCASA
		9	020012 21200	020005-21200	KOLBEN / ROTOR / PISTON / ROTORE / ÉMBOLO
		11	901380 00007	904333-00004	SATZ (KIT) SCHIEBER / VANES / PALETTE / PALETTE / EMPUJADOR
		15	000811 21200	000803-21200	SEITENDECKEL / LID LATERAL / COUVERCLE LATÉRAL / COPERCHIO LATERALE / TAPA LATERAL
		16	000711 21200	000701-21200	SEITENDECKEL / LID LATERAL / COUVERCLE LATÉRAL / COPERCHIO LATERALE / TAPA LATERAL
		68		909507-00000	FILTERPATRONE / FILTER CARTRIDGE / CARTOUCHE FILTRE / CARTUCCIA FILTRO / CARTUCHO DE FILTRO
		69	909587 00000		FILTERPATRONE (1x POLYESTER) / FILTER CARTRIDGE / CARTOUCHE FILTRE / CARTUCCIA FILTRO / CARTUCHO DE FILTRO
		76		025516-21100	DICHTUNG / GASKET / JOINT / GUARNIZIONE / JUNTA
		77		022802-21100	FILTERTRÄGER / FILTER HOLDER / SUPPORT FILTRE / SUPPORTO FILTRO / SOPORTE DE FILTRO
		83		952019-00000	SPANNHÜLSE / LOCATING PEG / DOUILLE DE ETRAGE / SPINE DI RISCNTRO / CASQUILLO TENSOR
		88		560203-21300	KÜHLER / COOLER / REFROIDISSEUR / RAFFREDDATORE / REFRIGERADOR
		91		909514-00000	FILTERPATRONE / FILTER CARTRIDGE / CARTOUCHE FILTRANTE / CARTUCCIA FILTRO / CARTUCHO DE FILTRO
		93		903800-70000	STIFTSCHRAUBE / STUD / GOUJON PRISONNIER / VITE PRIGIONIERA / PRISIONERO CON ROSCA
		94		947105-00000	SECHSKANTMUTTER / HEX.NUT / ECROU A 6 PANS / DADO ESAGONALE / TUERCA HEXAGONAL
		95		949450-00000	U-SCHEIBE / WASHER / RONDELLE / RONDELLA / ARANDELA
	230	019901 21100		UMLENKSTÜCK / RETURN PIECE / PIECE DE RETOUR / PEZZO INVERSIONE / PIEZA DE DESVIACIÓN	
	378	903245 00000		DICHTUNG / GASKET / JOINT / GUARNIZIONE / JUNTA	

²⁾ variantenabhängige Bauteile / variant-dependent components / composants variante-dependantes / componenti variante-dispendenti / componentes variante-dependientes

KDT 3.100	Variante 	Pos. ²⁾	Bestell Nr. / Ident No. / No. Identification / No. Identificazione / No. De pedido		Beschreibung / Description / Designation / Designazione / Desripcion
⑧ /6-71 - Korrosionsschutz - corrosion protection - protection contre la corrosion - protezione anti-corrosione - protección contra la corrosión		6	000111 21200	000101-21200	GEHÄUSE / PUMP BODY / CORP DE POMPE / CARCASSA / CARCASA
		9	020012 21200	020005-21200	KOLBEN / ROTOR / PISTON / ROTORE / ÉMBOLO
		11	901400 00007	904333-00004	SATZ (KIT) SCHIEBER / VANES / PALETTE / PALETTE / EMPUJADOR
		15	000811 21200	000803-21200	SEITENDECKEL / LID LATERAL / COUVERCLE LATÉRAL / COPERCHIO LATERALE / TAPA LATERAL
		16	000711 21200	000701-21200	SEITENDECKEL / LID LATERAL / COUVERCLE LATÉRAL / COPERCHIO LATERALE / TAPA LATERAL
		68		909507-00000	FILTERPATRONE / FILTER CARTRIDGE / CARTOUCHE FILTRE / CARTUCCIA FILTRO / CARTUCHO DE FILTRO
		69	909587 00000		FILTERPATRONE (1x POLYESTER) / FILTER CARTRIDGE / CARTOUCHE FILTRE / CARTUCCIA FILTRO / CARTUCHO DE FILTRO
		73	040205 21300	040201-21300	FILTERDECKEL / FILTER COVER / COUVERCLE DE FILTRE / COPERCHIO FILTRO / TAPA DE FILTRO
		76		025516-21100	DICHTUNG / GASKET / JOINT / GUARNIZIONE / JUNTA
		77		022802-21100	FILTERTRÄGER / FILTER HOLDER / SUPPORT FILTRE / SUPPORTO FILTRO / SOPORTE DE FILTRO
		83		952019-00000	SPANNHÜLSE / LOCATING PEG / DOUILLE DE ETRAGE / SPINE DI RISCONTRO / CASQUILLO TENSOR
		88		560203-21300	KÜHLER / COOLER / REFRIGERISSEUR / RAFFREDDATORE / REFRIGERADOR
		91		909514-00000	FILTERPATRONE / FILTER CARTRIDGE / CARTOUCHE FILTRANTE / CARTUCCIA FILTRO / CARTUCHO DE FILTRO
		93		903800-70000	STIFTSCHRAUBE / STUD / GOUJON PRISONNIER / VITE PRIGIONIERA / PRISIONERO CON ROSCA
		94		947105-00000	SECHSKANTMUTTER / HEX.NUT / ECROU A 6 PANS / DADO ESAGONALE / TUERCA HEXAGONAL
		95		949450-00000	U-SCHEIBE / WASHER / RONDELLE / RONDELLA / ARANDELA
		110	947401 00000	921500-50000	HUTMUTTER / CAP NUT / ÉCROU BORGNE / DADO CIECO / TUERCA DE CAPERUZA
	163	920801 21300	920800-21300	LUFTLEITRING / AIR GUIDE COVER RING / CAPOT DE CANALISATION DE L'AIR / CAPOTTA DEL CONDOTTARIA / CAPERUZA CONDUCTOR DE AIRE	
	230	019901 21100		UMLENKSTÜCK / RETURN PIECE / PIECE DE RETOUR / PEZZO INVERSIONE / PIEZA DE DESVIACIÓN	
	378	903245 00000		DICHTUNG / GASKET / JOINT / GUARNIZIONE / JUNTA	

²⁾ variantenabhängige Bauteile / variant-dependent components / composants variante-dependantes / componenti variante-dispendenti / componentes variante-dependientes

KDT 3.100	Variante 	Pos. ²⁾	Bestell Nr. / Ident No. / No. Identification / No. Identificazione / No. De pedido		Beschreibung / Description / Designation / Designazione / Desripcion
			  	  	
⑨ KDT 3.100/6-71HD KDT 3.120/6-71HD - Korrosionsschutz - corrosion protection - protection contre la corrosion - protezione anti-corrosione - protección contra la corrosión		6	000111 21300	000101-21300	GEHÄUSE / PUMP BODY / CORP DE POMPE / CARCASSA / CARCASA
		9	020012 21300	020004-21300	KOLBEN / ROTOR / PISTON / ROTORE / ÉMBOLO
		11	901385 00007	901334-00004	SATZ (KIT) SCHIEBER / VANES / PALETTE / PALETTE / EMPUJADOR
		15	000811 21300	000801-21300	SEITENDECKEL / LID LATERAL / COUVERCLE LATÉRAL / COPERCHIO LATERALE / TAPA LATERAL
		16	000711 21300	000701-21300	SEITENDECKEL / LID LATERAL / COUVERCLE LATÉRAL / COPERCHIO LATERALE / TAPA LATERAL
		68		909507-00000	FILTERPATRONE / FILTER CARTRIDGE / CARTOUCHE FILTRE / CARTUCCIA FILTRO / CARTUCHO DE FILTRO
		69	909587 00000		FILTERPATRONE (1x POLYESTER) / FILTER CARTRIDGE / CARTOUCHE FILTRE / CARTUCCIA FILTRO / CARTUCHO DE FILTRO
		73	040205 21300	040201-21300	FILTERDECKEL / FILTER COVER / COUVERCLE DE FILTRE / COPERCHIO FILTRO / TAPA DE FILTRO
		76		025516-21100	DICHTUNG / GASKET / JOINT / GUARNIZIONE / JUNTA
		77		022802-21100	FILTERTRÄGER / FILTER HOLDER / SUPPORT FILTRE / SUPPORTO FILTRO / SOPORTE DE FILTRO
		83		952019-00000	SPANNHÜLSE / LOCATING PEG / DOUILLE DE ETRAGE / SPINE DI RISCONTRO / CASQUILLO TENSOR
		88		560203-21300	KÜHLER / COOLER / REFRIGÉRISEUR / RAFFREDDATORE / REFRIGERADOR
		91		909514-00000	FILTERPATRONE / FILTER CARTRIDGE / CARTOUCHE FILTRANTE / CARTUCCIA FILTRO / CARTUCHO DE FILTRO
		93		903800-70000	STIFTSCHRAUBE / STUD / GOUJON PRISONNIER / VITE PRIGIONIERA / PRISIONERO CON ROSCA
		94		947105-00000	SECHSKANTMUTTER / HEX.NUT / ECROU A 6 PANS / DADO ESAGONALE / TUERCA HEXAGONAL
		95		949450-00000	U-SCHEIBE / WASHER / RONDELLE / RONDELLA / ARANDELA
		110	947401 00000	921500-50000	HUTMUTTER / CAP NUT / ÉCROU BORGNE / DADO CIECO / TUERCA DE CAPERUZA
	163	920801 21300	920800-21300	LUFTLEITRING / AIR GUIDE COVER RING / CAPOT DE CANALISATION DE L'AIR / CAPPOTTA DEL CONDOTTARIA / CAPERUZA CONDUCTOR DE AIRE	
	230	019901 21100		UMLENKSTÜCK / RETURN PIECE / PIECE DE RETOUR / PEZZO INVERSIONE / PIEZA DE DESVIACIÓN	
⑩ /0-54 - mit Abluftanschluß - with exhaust air connection - connexion d'évacuation d'air - bocchettoni di scarico - conexión de aire de escape		88		560203-21300	KÜHLER / COOLER / REFRIGÉRISEUR / RAFFREDDATORE / REFRIGERADOR
		230	019901 21100		UMLENKSTÜCK / RETURN PIECE / PIECE DE RETOUR / PEZZO INVERSIONE / PIEZA DE DESVIACIÓN

²⁾ variantenabhängige Bauteile / variant-dependent components / composants variante-dependantes / componenti variante-dispendenti / componentes variante-dependientes