

KDT 3.140

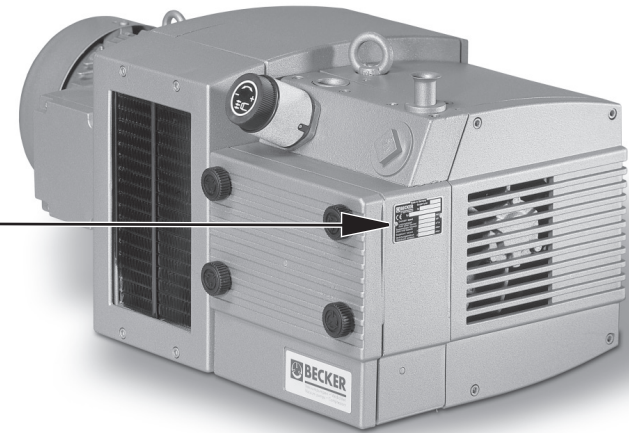
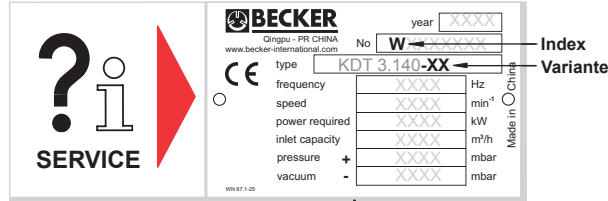
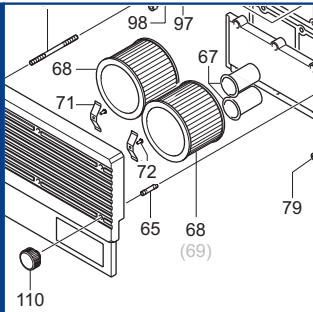

Ersatzteilliste
Spare parts list
Liste de pièces de rechange
Listino pezzi di ricambio
Lista de piezas de recambio
 Lista de peças sobresselentes
 Reserveonderdelenlijst
 Atsarginių dalių sąrašas
 Varuosad nimekirja
 Rezerves daļu saraksts

Reservedelsliste
 Reservdelslista
 Varaosaluettelo
 Reservedelsliste
 Wykaz części zamiennych
 Tartalékalkatrész lista
 Seznam náhradních dílů
 Seznam nadomestnih delov
 Zoznam náhradných dielov
 Rezervni dijelovi popis

Lista pieselor de schimb
Páirteanna spártha liosta
Κατάλογος ανταλλακτικών
Yedek parça listesi
Списък на резервните части
Перечень запасных частей
スペアパーツリスト
예비 부품 목록
备用零件目录



www.becker-international.com

Sales and service network

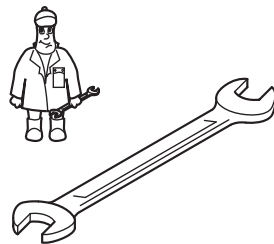

Wartung
Maintenance
Entretien
Manutenzione
Mantenimiento



Pos.	Menge ²⁾ Quantity Quantité Quantità Cantidad	Bestell-Nr. Ident No. No. Identification No. Identificazione No. de pedido	Bezeichnung Description Designation Designazione Descripción
□	1	549000 21300	Dichtungssatz, Complete set of seals, Jeu de joints, Kit di guarnizioni, Junta Completa
11	SATZ/KIT	901334 00004	Schieber, Rotor Vane, Palette, Empujador
11		901381 00004	" (KDT 3.140/0-52 + KDT 3.140/6)
11		901381 00007	" (KDT 3.140/6-29 + KDT 3.140/6-71)
11		901385 00007	" (KDT 3.140/6-71HD)
68	2	909507 00000	Filterpatrone, Filter cartridge, Cartouche Filtrante, Cartuccia filtro, Cartucho de filtro
68	1	909507 00000	" KDT 3.140/6
69	1	909587 00000	" KDT 3.140/6 - Polyester
91	1	909514 00000	Filterpatrone, Filter cartridge, Cartouche Filtrante, Cartuccia filtro, Cartucho de filtro
91	0	-	" KDT 3.140/6

²⁾ erforderliche Bestellmenge / necessary order quantity / quantité nécessaire / quantità di ordinazione necessari / cantidad necesario

KDT 3.140 Standard

Variante

KDT 3.140/XX

 ①
 US-motor

 ②
 B5-250

 ③-⑦
 /6, /0-52, /6-29,
 /6-71, /6-71HD
 - Korrosionsschutz
 - corrosion protection
 - protection contre la corrosion
 - protezione anti-corrosione
 - protección contra la corrosión

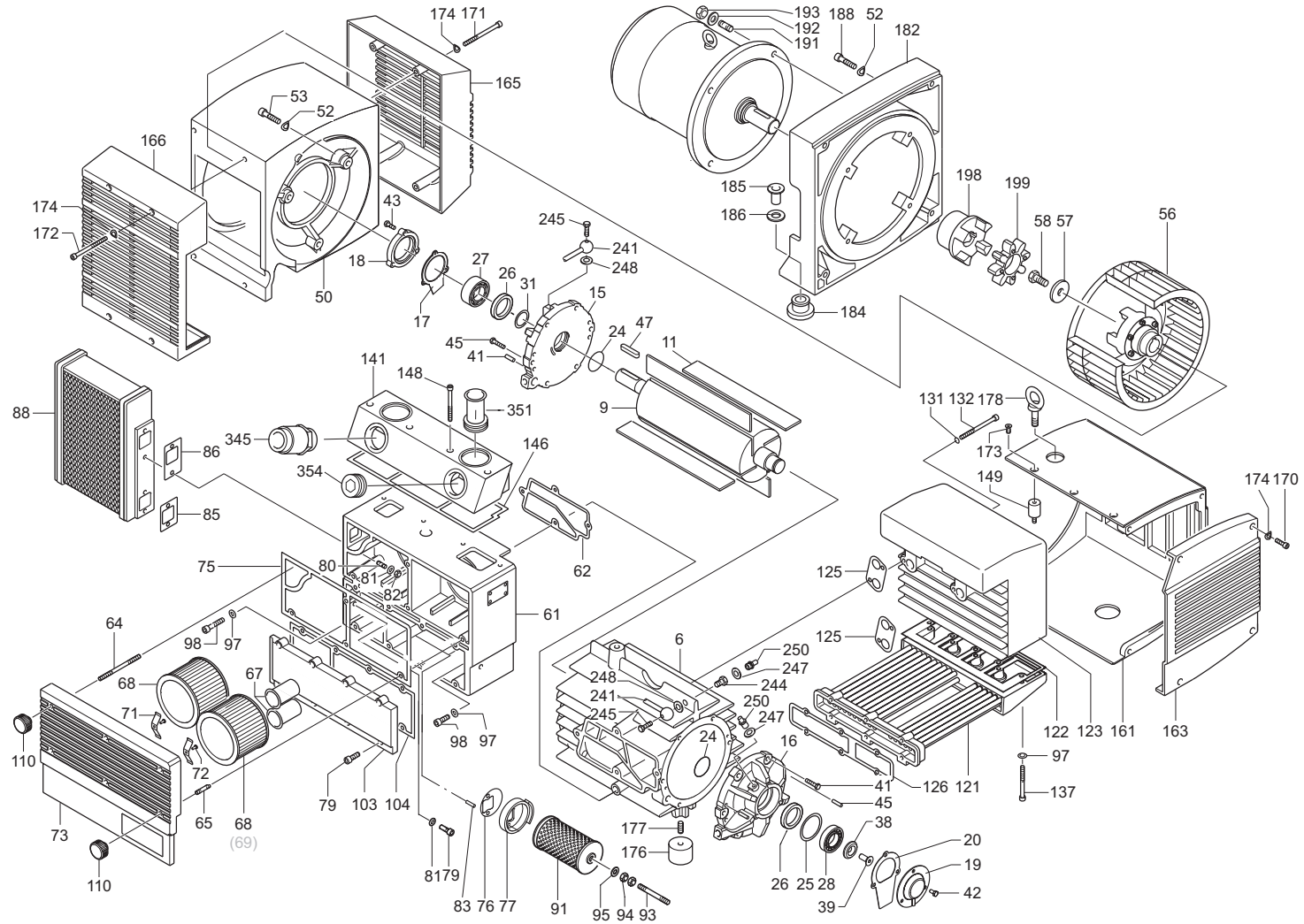
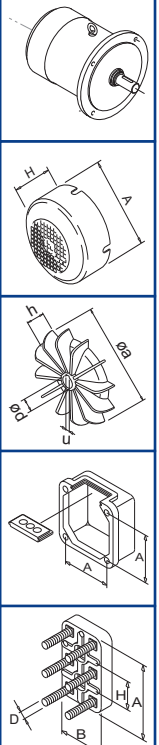

 ⑧
 /0-54
 - Kühlung
 - refrigeration
 - réfrigération
 - refrigerazione
 - refrigeración

SERVICE

W INDEX	Pos.	Bestell Nr.	Beschreibung	DE
KDT 3.140	■	549000 21300	DICHTUNGSSATZ ¹⁾	
	6	000101 21300	GEHÄUSE	
	9	020004 21300	KOLBEN	
	11	901334 00004	SCHIEBER (SATZ) ²⁾	
	15	000801 21300	SEITENDECKEL, LINKS	
	16	000701 21300	SEITENDECKEL, RECHTS	
	17	025512 21300	DICHTUNG	
	18	001101 21300	LAGERDECKEL	
	19	001006 21300	LAGERDECKEL	
	20	025513 21300	DICHTUNG	
	24	911305 00000	DICHTUNGSSCHLAUCH	
	25	917159 00000	AUSGLEICHSCHEIBE	
	26	906544 00000	WELLENDICHTRING	
	27	906621 00000	WÄLZLAGER	
	28	906664 00000	WÄLZLAGER	
	31	511400 10400	SATZ DISTANZSCHEIBEN	
	38	016801 21300	SPANNSCHEIBE	
	39	949807 00000	SENKSCHRAUBE	
	41	945224 00000	SECHSKANTSCHRAUBE	
	42	945218 00000	SECHSKANTSCHRAUBE	
	43	901804 00000	SECHSKANTSCHRAUBE	
45	948742 00000	PASSKERBSTIFT		
47	947736 00000	PASSFEDER		
50	053201 21305	LATERNE		
52	950308 00000	UNTERLEGSCHEIBE		
53	945331 00000	INNENSECHSKANTSCHRAUBE		
56	544500 21300	KUPPLUNGSHÄLFTE MIT VENTILATOR		
57	949409 00000	UNTERLEGSCHEIBE		
58	945270 00000	WELLENENDSCHRAUBE		
61	040102 21300	FILTERGEHÄUSE		
62	025501 21300	DICHTUNG		
64	951009 00000	STIFTSCHRAUBE		
65	951003 00000	STIFTSCHRAUBE		
67	964407 00000	SCHALLDÄMPFERROHR		
68	909507 00000	FILTERPATRONE (2x) ²⁾		
71	009000 27000	ANPRESSFEDER		
72	948750 00000	BLINDNIET		
73	040204 21300	FILTERDECKEL		
75	025518 21300	DICHTUNG		
76	025516 21100	DICHTUNG		
77	022802 21100	FILTERTRÄGER		
79	945321 00000	INNENSECHSKANTSCHRAUBE		
80	946971 00000	STIFTSCHRAUBE		
81	947504 00000	UNTERLEGSCHEIBE		
82	947104 00000	SECHSKANTMUTTER		
83	952019 00000	SPANNHÜLSE		
85	025514 21100	DICHTUNG		
86	025515 21100	DICHTUNG		
88	560203 21300	KUEHLER		
91	909514 00000	FILTERPATRONE (1x) ²⁾		
93	903800 70000	STIFTSCHRAUBE		
94	947105 00000	SECHSKANTMUTTER		
95	949450 00000	U-SCHEIBE		
97	950304 00000	U-SCHEIBE		
98	945321 00000	INNENSECHSKANTSCHRAUBE		
103	068801 21300	STAUBABSCHIEDERDECKEL		
104	025515 21300	DICHTUNG		
110	921500 50000	HANDGRIFF		
121	560204 21300	KÜHLER		

W INDEX	Pos.	Bestell Nr.	Beschreibung	DE
	122	025506 21300	DICHTUNG	
	123	066802 21300	DRUCKANSCHLUSSKASTEN	
	125	025504 21300	DICHTUNG	
	126	025514 21300	DICHTUNG	
	131	948021 00000	DICHTRING	
	132	945374 00020	INNENSECHSKANTSCHRAUBE	
	137	945322 00000	INNENSECHSKANTSCHRAUBE	
	141	016604 21300	ANSCHLUSSLEISTE	
	146	025507 21300	DICHTUNG	
	148	945364 00000	INNENSECHSKANTSCHRAUBE	
	149	741310 30000	GUMMIPUFFER	
	161	918300 21300	ABDECKHAUBE	
	163	920800 21300	LUFTLEITRING	
	165	960700 21300	LÜFTERHAUBE	
	166	960701 21300	LÜFTERHAUBE	
	170	945321 00010	INNENSECHSKANTSCHRAUBE	
	171	945371 00010	INNENSECHSKANTSCHRAUBE	
	172	945372 00010	INNENSECHSKANTSCHRAUBE	
	173	949806 00000	SENKSCHRAUBE	
	174	951703 00000	FEDERSCHEIBE	
	176	741302 00000	GUMMIPUFFER	
	177	945634 00000	GEWINDESTIFT	
	178	948802 00000	RINGSCHRAUBE	
	182	014903 21305	ZWISCHENFLANSCH	
	184	951916 00000	KABELTÜLLE	
	185	948772 00000	ROHRNIETE	
	186	947508 00000	UNTERLEGSCHEIBE	
	188	945335 00000	INNENSECHSKANTSCHRAUBE	
	191	951022 00000	STIFTSCHRAUBE	
	192	947506 00000	UNTERLEGSCHEIBE	
	193	947106 00000	SECHSKANTMUTTER	
	198	902100 21900	KUPPLUNGSHÄLFTE (MOT)	
	199	902210 00000	KUPPLUNGSSCHEIBE	
	241	012200 21300	LEITUNG	
	244	912300 00000	ANSCHLUSSSCHRAUBE	
	245	009400 19000	KUGELSTÜCKSCHRAUBE	
	247	948074 00000	DICHTRING	
	248	948021 00000	DICHTRING	
	250	949002 00000	SCHMIERNIPPEL	
	345	728000 99622	DRUCKREGULIERVENTIL / 0,6 BAR	
	345	728001 99622	DRUCKREGULIERVENTIL / 1,0 BAR	
	345	728002 99622	DRUCKREGULIERVENTIL / 2,0 BAR	
	345	728003 99622	DRUCKREGULIERVENTIL / 0,3 BAR	
	351	964313 00000	SCHALLDÄMPFERDÜSE	
	354	912805 00000	VERSCHLUSSSTOPFEN	
		743303 00000	SPEZIALFETT (FETTPRESSE, 50g)	

¹⁾ Dichtungssatz - 54900021300 - Pos.: 17, 20, 24, 62, 75, 76, 85, 86, 104, 122, 125, 126, 146
²⁾ erforderliche Bestellmenge / Wartung

W INDEX	Pos.	Ident No.	Description	
KDT 3.140	▣	549000 21300	SET OF SEALS ¹⁾	
	6	000101 21300	PUMP BODY	
	9	020004 21300	ROTOR	
	11	901334 00004	CARBON VANES (KIT) ²⁾	
	15	000801 21300	LID, LEFT	
	16	000701 21300	LID, RIGHT	
	17	025512 21300	GASKET	
	18	001101 21300	BEARING COVER	
	19	001006 21300	BEARING COVER	
	20	025513 21300	GASKET	
	24	911305 00000	SEAL	
	25	917159 00000	COMPENSATING DISC	
	26	906544 00000	SHAFT-SEALING RING	
	27	906621 00000	BALL BEARING	
	28	906664 00000	BALL BEARING	
	31	511400 10400	SET DISTANCE DISC	
	38	016801 21300	CLAMPING DISC	
	39	949807 00000	SCREW	
	41	945224 00000	HEX-HEAD SCREW	
	42	945218 00000	HEX-HEAD SCREW	
	43	901804 00000	HEX-HEAD SCREW	
	45	948742 00000	STRAIGHT PIN	
	47	947736 00000	KEY	
	50	053201 21305	CONNECTION FLANGE	
	52	950308 00000	WASHER	
	53	945331 00000	SOCKET HEAD SCREW	
	56	544500 21300	COUPLING WITH FAN	
	57	949409 00000	WASHER	
	58	945270 00000	SHAFT END BOLD	
	61	040102 21300	FILTER HOUSING	
	62	025501 21300	GASKET	
	64	951009 00000	STUD	
	65	951003 00000	STUD	
	67	964407 00000	SILENCER TUBE	
	68	909507 00000	FILTER CARTRIDGE (2x) ²⁾	
	71	009000 27000	LEAF SPRING	
	72	948750 00000	BLIND RIVET	
	73	040204 21300	FILTER COVER	
	75	025518 21300	GASKET	
	76	025516 21100	GASKET	
	77	022802 21100	FILTER HOLDER	
	79	945321 00000	SOCKET HEAD SCREW	
	80	946971 00000	STUD	
	81	947504 00000	WASHER	
	82	947104 00000	HEX.NUT	
	83	952019 00000	LOCATING PEG	
	85	025514 21100	GASKET	
	86	025515 21100	GASKET	
	88	560203 21300	COOLER	
	91	909514 00000	FILTER CARTRIDGE (1x) ²⁾	
	93	903800 70000	STUD	
	94	947105 00000	HEX.NUT	
	95	949450 00000	WASHER	
	97	950304 00000	WASHER	
	98	945321 00000	SOCKET HEAD SCREW	
	103	068801 21300	DUST SEPARATOR COVER	
	104	025515 21300	GASKET	
	110	921500 50000	HANDLE	
	121	560204 21300	COOLER	

W INDEX	Pos.	Ident No.	Description	
	122	025506 21300	GASKET	
	123	066802 21300	PRESSURE CONNECTION BOX	
	125	025504 21300	GASKET	
	126	025514 21300	GASKET	
	131	948021 00000	SEALING RING	
	132	945374 00020	SOCKET HEAD SCREW	
	137	945322 00000	SOCKET HEAD SCREW	
	141	016604 21300	CONNECTING PIECE	
	146	025507 21300	GASKET	
	148	945364 00000	SOCKET HEAD SCREW	
	149	741310 30000	RUBBER BUFFER	
	161	918300 21300	COVERING HOOD	
	163	920800 21300	AIR GUIDE COVER RING	
	165	960700 21300	VENTILATOR HOOD	
	166	960701 21300	VENTILATOR HOOD	
	170	945321 00010	SOCKET HEAD SCREW	
	171	945371 00010	SOCKET HEAD SCREW	
	172	945372 00010	SOCKET HEAD SCREW	
	173	949806 00000	COUNTERSUNK SCREW	
	174	951703 00000	SPRING DISC	
	176	741302 00000	RUBBER BUFFER	
	177	945634 00000	THREADED PIN	
	178	948802 00000	RING SCREW	
	182	014903 21305	FLANGE	
	184	951916 00000	RUBBER BUSHING	
	185	948772 00000	PIPE RIVET	
	186	947508 00000	WASHER	
	188	945335 00000	SOCKET HEAD SCREW	
	191	951022 00000	STUD	
	192	947506 00000	WASHER	
	193	947106 00000	HEX.NUT	
	198	902100 21900	COUPLING	
	199	902210 00000	COUPLING DISC	
	241	012200 21300	OIL-PIPE	
	244	912300 00000	CONNECTING SCREW	
	245	009400 19000	HOLLOW HOLDING SCREW	
	247	948074 00000	SEALING RING	
	248	948021 00000	SEALING RING	
	250	949002 00000	GREASE NIPPLE	
	345	728000 99622	PRESSURE REGULATION VALVE / 8,7 PSI	
	345	728001 99622	PRESSURE REGULATION VALVE / 14,5 PSI	
	345	728002 99622	PRESSURE REGULATING VALVE / 29 PSI	
	345	728003 99622	PRESSURE REGULATING VALVE / 4,35 PSI	
	351	964313 00000	NOZZLE	
	354	912805 00000	PLUG	
		743303 00000	 SPECIAL GREASE (GREASE PRESS, 50g)	

¹⁾ Set of seals - 54900021300 - Pos.: 17, 20, 24, 62, 75, 76, 85, 86, 104, 122, 125, 126, 146
²⁾ necessary order quantity / maintenance

W INDICE	Pos.	No. Identification	Designation	FR	
KDT 3.140	■	549000 21300	JEU DE JOINTS ¹⁾		
	6	000101 21300	CORP DE POMPE		
	9	020004 21300	PISTON		
	11	901334 00004	PALETTE DE CHARBON (KIT) ²⁾		
	15	000801 21300	COUVERCLE A GAUCHE		
	16	000701 21300	COUVERCLE A DROITE		
	17	025512 21300	JOINT		
	18	001101 21300	COUVERCLE DE ROULEMENTE		
	19	001006 21300	COUVERCLE DE ROULEMENTE		
	20	025513 21300	JOINT		
24	911305 00000	JOINT			
25	917159 00000	DISQUE DE COMPENSATION			
26	906544 00000	BAGUE D'ETANCHEITE P.L'AXE			
27	906621 00000	ROULEMENT A BILLES			
28	906664 00000	ROULEMENT A BILLES			
31	511400 10400	JEU DISQUE DE TOLERANCE			
38	016801 21300	DISQUE DE SERRAGE			
39	949807 00000	VIS			
41	945224 00000	VIS HEXAGONALE			
42	945218 00000	VIS HEXAGONALE			
43	901804 00000	VIS HEXAGONALE			
45	948742 00000	GOUPILLE CYLINDRIQUE			
47	947736 00000	CLAVETTE			
50	053201 21305	BRIDE DE RACCORDEMENT			
52	950308 00000	RONDELLE			
53	945331 00000	VIS HEXAGONALE INTERNE			
56	544500 21300	ACCOUPLLEMENT AVEC VENTILATEUR			
57	949409 00000	RONDELLE			
58	945270 00000	VIS BOUT D'ARBRE			
61	040102 21300	BOITE POUR FILTRE			
62	025501 21300	JOINT			
64	951009 00000	PRISONNIER			
65	951003 00000	PRISONNIER			
67	964407 00000	TUBE SILENCIEUX			
68	909507 00000	CARTOUCHE FILTRANTE (2x) ²⁾			
71	009000 27000	RESSORT-JAME			
72	948750 00000	RIVET AVEUGLIE			
73	040204 21300	COUVERCLE DE FILTRE			
75	025518 21300	JOINT			
76	025516 21100	JOINT			
77	022802 21100	SUPPORT FILTRE			
79	945321 00000	VIS HEXAGONALE INTERNE			
80	946971 00000	PRISONNIER			
81	947504 00000	RONDELLE			
82	947104 00000	ECROU A 6 PANS			
83	952019 00000	DOUILLE DE ETRAGE			
85	025514 21100	JOINT			
86	025515 21100	JOINT			
88	560203 21300	REFROIDISSEUR			
91	909514 00000	CARTOUCHE FILTRANTE (1x) ²⁾			
93	903800 70000	PRISONNIER			
94	947105 00000	ECROU A 6 PANS			
95	949450 00000	RONDELLE			
97	950304 00000	RONDELLE			
98	945321 00000	VIS HEXAGONALE INTERNE			
103	068801 21300	COUVERCLE			
104	025515 21300	JOINT			
110	921500 50000	POIGNEE			
121	560204 21300	REFROIDISSEUR			

W INDICE	Pos.	No. Identification	Designation	FR	
	122	025506 21300	JOINT		
	123	066802 21300	BOITIER DE RACCORD DE REFOULEMENT		
	125	025504 21300	JOINT		
	126	025514 21300	JOINT		
	131	948021 00000	JOINT		
	132	945374 00020	VIS HEXAGONALE INTERNE		
	137	945322 00000	VIS HEXAGONALE INTERNE		
	141	016604 21300	PIECE RACCORD		
	146	025507 21300	JOINT		
	148	945364 00000	VIS HEXAGONALE INTERNE		
	149	741310 30000	AMORTISSEUR EN CAOUTCHOUC		
	161	918300 21300	CARTER		
	163	920800 21300	CAPOT DE CANALISATION DE L'AIR		
	165	960700 21300	CARTER DE VENTILATEUR		
	166	960701 21300	CARTER DE VENTILATEUR		
	170	945321 00010	VIS HEXAGONALE INTERNE		
	171	945371 00010	VIS HEXAGONALE INTERNE		
	172	945372 00010	VIS HEXAGONALE INTERNE		
	173	949806 00000	VIS A TÊTE NOYÉE		
	174	951703 00000	DISQUE DE RESSORT		
	176	741302 00000	AMORTISSEUR EN CAOUTCHOUC		
	177	945634 00000	GOUPILLE FILETEE		
	178	948802 00000	PITON		
	182	014903 21305	BRIDE		
	184	951916 00000	PROTECTION EN CAOUTCHOUC		
	185	948772 00000	RIVET TUBE		
	186	947508 00000	RONDELLE		
	188	945335 00000	VIS HEXAGONALE INTERNE		
	191	951022 00000	PRISONNIER		
	192	947506 00000	RONDELLE		
	193	947106 00000	ECROU A 6 PANS		
	198	902100 21900	ACCOUPLLEMENT		
	199	902210 00000	DISQUE D'ACCOUPLLEMENT		
	241	012200 21300	TUYEAU DE GRAISSAGE		
	244	912300 00000	VIS DE RACCORD		
	245	009400 19000	VIS CREUSE DE FIXATION		
	247	948074 00000	JOINT		
	248	948021 00000	JOINT		
	250	949002 00000	GRAISSEUR		
	345	728000 99622	SOUPAPE REGLAGE PRESSION / 0,6 BAR		
	345	728001 99622	SOUPAPE REGLAGE PRESSION / 1,0 BAR		
	345	728002 99622	SOUPAPE REGLAGE PRESSION / 2,0 BAR		
	345	728003 99622	SOUPAPE REGLAGE PRESSION / 0,3 BAR		
	351	964313 00000	BUSE		
	354	912805 00000	BOUCHON		
		743303 00000	GRAISSE SPÉCIFIQUE (POMPE À GRAISSE, 50g)		

¹⁾ Jeu de joints - 54900021300 - Pos.: 17, 20, 24, 62, 75, 76, 85, 86, 104, 122, 125, 126, 146

²⁾ quantité nécessaire / entretien

W INDICE	Pos.	No. Identificazione	Designazione	IT	
KDT 3.140	■	549000 21300	SERIE DI GUARNIZIONE ¹⁾		
	6	000101 21300	CARCASSA		
	9	020004 21300	ROTORE		
	11	901334 00004	PALETTE DI CHARBONE (KIT) ²⁾		
	15	000801 21300	COPERCHIO SINISTRA		
	16	000701 21300	COPERCHIO DESTRA		
	17	025512 21300	GUARNIZIONE		
	18	001101 21300	COPERCHIO CUSCINETTO		
	19	001006 21300	COPERCHIO CUSCINETTO		
	20	025513 21300	GUARNIZIONE		
24	911305 00000	GUARNIZIONE			
25	917159 00000	DISCO COMPENSATORE			
26	906544 00000	GUARNIZIONE PER L'ALBERO			
27	906621 00000	CUSCINETTO A SFERA			
28	906664 00000	CUSCINETTO A SFERA			
31	511400 10400	SERIE DISCO GIUOCO			
38	016801 21300	DISCO DI FISSAGGIO			
39	949807 00000	VITE			
41	945224 00000	VITE ESAGONALE			
42	945218 00000	VITE ESAGONALE			
43	901804 00000	VITE ESAGONALE			
45	948742 00000	PERNO			
47	947736 00000	CHIAVETTA			
50	053201 21305	FLANGIA DI RACCORDE			
52	950308 00000	RONDELLA			
53	945331 00000	VITE ESAGONALE INTERNA			
56	544500 21300	GIUNTO CON VENTILATORE			
57	949409 00000	RONDELLA			
58	945270 00000	VITE DI CHIUSURA ALBERO			
61	040102 21300	CONTENITORE FILTRO			
62	025501 21300	GUARNIZIONE			
64	951009 00000	L'ASTA A VITE			
65	951003 00000	L'ASTA A VITE			
67	964407 00000	TUBO SILENZIATORE			
68	909507 00000	CARTUCCIA FILTRO (2x) ²⁾			
71	009000 27000	MOLLA			
72	948750 00000	RIVETTO CIECO			
73	040204 21300	COPERCHIO FILTRO			
75	025518 21300	GUARNIZIONE			
76	025516 21100	GUARNIZIONE			
77	022802 21100	SUPPORTO FILTRO			
79	945321 00000	VITE ESAGONALE INTERNA			
80	946971 00000	L'ASTA A VITE			
81	947504 00000	RONDELLA			
82	947104 00000	DADO ESAGONALE			
83	952019 00000	SPINE DI RISCONTRO			
85	025514 21100	GUARNIZIONE			
86	025515 21100	GUARNIZIONE			
88	560203 21300	RAFFREDDATORE			
91	909514 00000	CARTUCCIA FILTRO (1x) ²⁾			
93	903800 70000	L'ASTA A VITE			
94	947105 00000	DADO ESAGONALE			
95	949450 00000	RONDELLA			
97	950304 00000	RONDELLA			
98	945321 00000	VITE ESAGONALE INTERNA			
103	068801 21300	COPERCHIO			
104	025515 21300	GUARNIZIONI			
110	921500 50000	MANETTA			
121	560204 21300	RAFFREDDATORE			

W INDICE	Pos.	No. Identificazione	Designazione	IT	
	122	025506 21300	GUARNIZIONE		
	123	066802 21300	SCATOLA DI RACCORDO DI MANDATA		
	125	025504 21300	GUARNIZIONE		
	126	025514 21300	GUARNIZIONI		
	131	948021 00000	ANELLO GUARNIZIONE		
	132	945374 00020	VITE ESAGONALE INTERNA		
	137	945322 00000	VITE ESAGONALE INTERNA		
	141	016604 21300	PEZZI RACCORDI		
	146	025507 21300	GUARNIZIONE		
	148	945364 00000	VITE ESAGONALE INTERNA		
	149	741310 30000	AMMORTIZZATORE IN GOMMA		
	161	918300 21300	CARTER		
	163	920800 21300	CAPPOTTA DEL CONDOTTA ARIA		
	165	960700 21300	CARTER VENTILATORE		
	166	960701 21300	CARTER VENTILATORE		
	170	945321 00010	VITE ESAGONALE INTERNA		
	171	945371 00010	VITE ESAGONALE INTERNA		
	172	945372 00010	VITE ESAGONALE INTERNA		
	173	949806 00000	VITE A TESTA SVASATA		
	174	951703 00000	DISCO A MOLLA		
	176	741302 00000	AMMORTIZZATORE IN GOMMA		
	177	945634 00000	SPINA FILETTATURA		
	178	948802 00000	GANCIO		
	182	014903 21305	FLANGIA		
	184	951916 00000	PROTEZIONE IN GOMMA		
	185	948772 00000	CHiodo TUBOLARE		
	186	947508 00000	RONDELLA		
	188	945335 00000	VITE ESAGONALE INTERNA		
	191	951022 00000	L'ASTA A VITE		
	192	947506 00000	RONDELLA		
	193	947106 00000	DADO ESAGONALE		
	198	902100 21900	GIUNTO		
	199	902210 00000	DISCO GIUNTO		
	241	012200 21300	CONDOTTO		
	244	912300 00000	ATTACO FILETTATO		
	245	009400 19000	VITE PASSAGGIO OLIO		
	247	948074 00000	ANELLO GUARNIZIONE		
	248	948021 00000	ANELLO GUARNIZIONE		
	250	949002 00000	RACCORDO DI LUBRIFICAZIONE		
	345	728000 99622	VALVOLA REGOLAZIONE PRESSIONE / 0,6 BAR		
	345	728001 99622	VALVOLA REGOLAZIONE PRESSIONE / 1,0 BAR		
	345	728002 99622	VALVOLA REGOLAZIONE PRESSIONE / 2,0 BAR		
	345	728003 99622	VALVOLA REGOLAZIONE PRESSIONE / 0,3 BAR		
	351	964313 00000	UGGELLO		
	354	912805 00000	TAPPO DI CHIUSURA		
		743303 00000	GRASSO SPECIALE (INGRASSATORE A PISTOLA, 50g)		







¹⁾ Serie di guarnizione - 54900021300 - Pos.: 17, 20, 24, 62, 75, 76, 85, 86, 104, 122, 125, 126, 146
²⁾ quantità di ordinazione necessari / manutenzione

W INDICE	Pos.	No. De pedido	Descripción	ES	
				ES	
KDT 3.140	▣	549000 21300	JUNTA COMPLETA ¹⁾		
	6	000101 21300	CARCASA		
	9	020004 21300	ÉMBOLO, ACABADO		
	11	901334 00004	EMPUJADOR (KIT) ²⁾		
	15	000801 21300	TAPA LATERAL		
	16	000701 21300	TAPA LATERAL DERECHA		
	17	025512 21300	JUNTA		
	18	001101 21300	TAPA DE COJINETE		
	19	001006 21300	TAPA DE COJINETE		
	20	025513 21300	JUNTA		
24	911305 00000	MANGUERA DE JUNTA			
25	917159 00000	ARANDELA DE COMPENSACIÓN			
26	906544 00000	ANILLO DE JUNTA DE ÁRBOL			
27	906621 00000	COJINETE DE RODAMIENTO			
28	906664 00000	COJINETE DE RODAMIENTO			
31	511400 10400	JUEGO DE ARANDELAS DISTANCIADORAS			
38	016801 21300	ARANDELA TENSORA			
39	949807 00000	TORNILLO AVELLANADO			
41	945224 00000	TORNILLO DE CABEZA HEXAGONAL			
42	945218 00000	TORNILLO DE CABEZA HEXAGONAL			
43	901804 00000	TORNILLO DE CABEZA HEXAGONAL			
45	948742 00000	PASADOR ENTALLADO DE AJUSTE			
47	947736 00000	LENGÜETA DE AJUSTE			
50	053201 21305	FAROL			
52	950308 00000	ARANDELA			
53	945331 00000	TORNILLO HEXAGONAL INTERIOR			
56	544500 21300	MITAD DE ACOPLAMIENTO CON VENTILADOR			
57	949409 00000	ARANDELA			
58	945270 00000	TORNILLO TERMINAL DE ÁRBOL			
61	040102 21300	CARCASA DE FILTRO			
62	025501 21300	JUNTA			
64	951009 00000	ESPÁRRAGO			
65	951003 00000	ESPÁRRAGO			
67	964407 00000	TUBO DE SILENCIADOR			
68	909507 00000	CARTUCHO DE FILTRO (2x) ²⁾			
71	009000 27000	MUELLE DE PRESIÓN			
72	948750 00000	REMACHE CIEGO			
73	040204 21300	TAPA DE FILTRO			
75	025518 21300	JUNTA			
76	025516 21100	JUNTA			
77	022802 21100	SOPORTE DE FILTRO			
79	945321 00000	TORNILLO HEXAGONAL INTERIOR			
80	946971 00000	ESPÁRRAGO			
81	947504 00000	ARANDELA			
82	947104 00000	TUERCA HEXAGONAL			
83	952019 00000	CASQUILLO TENSOR			
85	025514 21100	JUNTA			
86	025515 21100	JUNTA			
88	560203 21300	REFRIGERADOR			
91	909514 00000	CARTUCHO DE FILTRO (1x) ²⁾			
93	903800 70000	ESPÁRRAGO			
94	947105 00000	TUERCA HEXAGONAL			
95	949450 00000	ARANDELA			
97	950304 00000	ARANDELA			
98	945321 00000	TORNILLO HEXAGONAL INTERIOR			
103	068801 21300	TAPA DE SEPARADOR DE POLVO			
104	025515 21300	JUNTA			
110	921500 50000	EMPUÑADURA			
121	560204 21300	REFRIGERADOR			

W INDICE	Pos.	No. De pedido	Descripción	ES	
				ES	
	122	025506 21300	JUNTA		
	123	066802 21300	CAJA DE EMPALME DE PRESIÓN		
	125	025504 21300	JUNTA		
	126	025514 21300	JUNTA		
	131	948021 00000	ANILLO DE JUNTA		
	132	945374 00020	TORNILLO HEXAGONAL INTERIOR		
	137	945322 00000	TORNILLO HEXAGONAL INTERIOR		
	141	016604 21300	PIEZA DE EMPALME		
	146	025507 21300	JUNTA		
	148	945364 00000	TORNILLO HEXAGONAL INTERIOR		
	149	741310 30000	AMORTIGUADOR DE GOMA		
	161	918300 21300	CAPERUZA DE RECUBRIMIENTO		
	163	920800 21300	CAPERUZA CONDUCTOR DE AIRE		
	165	960700 21300	CAPERUZA DE VENTILADOR		
	166	960701 21300	CAPERUZA DE VENTILADOR		
	170	945321 00010	TORNILLO HEXAGONAL INTERIOR		
	171	945371 00010	TORNILLO HEXAGONAL INTERIOR		
	172	945372 00010	TORNILLO HEXAGONAL INTERIOR		
	173	949806 00000	TORNILLO AVELLANADO		
	174	951703 00000	ARANDELA ELÁSTICA		
	176	741302 00000	AMORTIGUADOR DE GOMA		
	177	945634 00000	VARILLA ROSCADA		
	178	948802 00000	TORNILLO DE CÁNCAMO		
	182	014903 21305	BRIDA INTERMEDIA		
	184	951916 00000	BOQUILLA DE CABLE		
	185	948772 00000	REMACHE TUBULAR		
	186	947508 00000	ARANDELA		
	188	945335 00000	TORNILLO HEXAGONAL INTERIOR		
	191	951022 00000	ESPÁRRAGO		
	192	947506 00000	ARANDELA		
	193	947106 00000	TUERCA HEXAGONAL		
	198	902100 21900	MITAD DE ACOPLAMIENTO (MOT)		
	199	902210 00000	DISCO DE ACOPLAMIENTO		
	241	012200 21300	CONDUCTO		
	244	912300 00000	TORNILLO DE EMPALME		
	245	009400 19000	TORNILLO DE PIEZA ESFÉRICA		
	247	948074 00000	ANILLO DE JUNTA		
	248	948021 00000	ANILLO DE JUNTA		
	250	949002 00000	BOQUILLA DE TOLVA DE LUBRICACIÓN		
	345	728000 99622	VÁLVULA REGULADORA DE PRESIÓN / 0,6 BAR		
	345	728001 99622	VÁLVULA REGULADORA DE PRESIÓN / 1,0 BAR		
	345	728002 99622	VÁLVULA REGULADORA DE PRESIÓN / 2,0 BAR		
	345	728003 99622	VÁLVULA REGULADORA DE PRESIÓN / 0,3 BAR		
	351	964313 00000	TOBERA DE SILENCIADOR		
	354	912805 00000	TAPÓN DE DESGASTE		
		743303 00000	GRASA ESPECIAL (PISTOLA DE GRASA, 50g)		

¹⁾ Junta completa - 54900021300 - Pos.: 17, 20, 24, 62, 75, 76, 85, 86, 104, 122, 125, 126, 146



²⁾ cantidad necesario / mantenimiento

KDT 3.140	Variante 	Pos. ²⁾	Bestell Nr. / Ident No. / No. Identification / No. Identificazione / No. De pedido		Beschreibung / Description / Designation / Designazione / Desripcion
			  	  	
① US-motor		191	951018 00000	951022-00000	STIFTSCHRAUBE / STUD / GOUJON PRISONNIER / VITE PRIGIONIERA / PRISIONERO CON ROSCA
		198		902100-21900	MOTORKUPPLUNG / COUPLING / ACCOUPLEMENT / GIUNTO / ACOPLAMIENTO
		234	037900 10400		ZWISCHENFLANSCH / INTERMEDIATE FLANGE / BRIDE INTERMEDIAIRE / FLANGE INTERMEDIA / BRIDA INTERMEDIA
		236	902100 21300		MOTORKUPPLUNG / COUPLING / ACCOUPLEMENT / GIUNTO / ACOPLAMIENTO
② B5-250		182	014902 21305	014903-21305	ZWISCHENFLANSCH / INTERMEDIATE FLANGE / BRIDE INTERMEDIAIRE / FLANGE INTERMEDIA / BRIDA INTERMEDIA
		191	951018 00000	951022-00000	STIFTSCHRAUBE / STUD / GOUJON PRISONNIER / VITE PRIGIONIERA / PRISIONERO CON ROSCA
		198	902109 00000	902100-00000	MOTORKUPPLUNG / COUPLING / ACCOUPLEMENT / GIUNTO / ACOPLAMIENTO
③ /0-52 - Korrosionsschutz - corrosion protection - protection contre la corrosion - protezione anti-corrosione - protección contra la corrosión		9	020005 21300	020004-21300	KOLBEN / ROTOR / PISTON / ROTORE / ÉMBOLO
		11	901381 00004	901334-00004	SATZ (KIT) SCHIEBER / VANES / PALETTE / PALETTE / EMPUJADOR
		345		72800X-99622	DRUCKREGULIERVENTIL / PRESSURE REGULATING VALVE / SOUPAPE REGLAGE PRESSION / VALVOLA REGOLAZIONE PRESSIONE / VÁLVULA REGULADORA DE PRESIÓN
		403	734000 02000		DRUCKREGULIERVENTIL 2,2 BAR / PRESSURE REGULATING VALVE 32 PSI / SOUPAPE REGLAGE PRESSION 2,2 BAR / VALVOLA REGOLAZIONE PRESSIONE 2,2 BAR / VÁLVULA REGULADORA DE PRESIÓN 2,2 BAR
④ /0-54 - Kühlung - refrigeration - réfrigération - refrigerazione - refrigeración		88		560203-21300	KÜHLER / COOLER / REFROIDISSEUR / RAFFREDDATORE / REFRIGERADOR
		230	019901 21100		UMLLENKSTÜCK / RETURN PIECE / PIECE DE RETOUR / PEZZO INVERSIONE / PIEZA DE DESVIACIÓN



²⁾ variantenabhängige Bauteile / variant-dependent components / composants variante-dependantes / componenti variante-dispendenti / componentes variante-dependientes

KDT 3.140	Variante 	Pos. ²⁾	Bestell Nr. / Ident No. / No. Identification / No. Identificazione / No. De pedido		Beschreibung / Description / Designation / Designazione / Desripcion
④ /6 - Korrosionsschutz - corrosion protection - protection contre la corrosion - protezione anti-corrosione - protección contra la corrosión		6	000111 21300	000101-21300	GEHÄUSE / PUMP BODY / CORP DE POMPE / CARCASSA / CARCASA
		9	020011 21300	020004-21300	KOLBEN / ROTOR / PISTON / ROTORE / ÉMBOLO
		11	901381 00004	901334-00004	SATZ (KIT) SCHIEBER / VANES / PALETTE / PALETTE / EMPUJADOR
		15	000811 21300	000801-21300	SEITENDECKEL / LID LATERAL / COUVERCLE LATÉRAL / COPERCHIO LATERALE / TAPA LATERAL
		16	000711 21300	000701-21300	SEITENDECKEL / LID LATERAL / COUVERCLE LATÉRAL / COPERCHIO LATERALE / TAPA LATERAL
		68		909507-00000	FILTERPATRONE (1x) / FILTER CARTRIDGE / CARTOUCHE FILTRE / CARTUCCIA FILTRO / CARTUCHO DE FILTRO
		69	909587 00000		FILTERPATRONE (1x POLYESTER) / FILTER CARTRIDGE / CARTOUCHE FILTRE / CARTUCCIA FILTRO / CARTUCHO DE FILTRO
		76		025516-21100	DICHTUNG / GASKET / JOINT / GUARNIZIONE / JUNTA
		77		022802-21100	FILTERTRÄGER / FILTER HOLDER / SUPPORT FILTRE / SUPPORTO FILTRO / SOPORTE DE FILTRO
		83		952019-00000	SPANNHÜLSE / LOCATING PEG / DOUILLE DE ETRAGE / SPINE DI RISCONTRO / CASQUILLO TENSOR
		91		909514-00000	FILTERPATRONE / FILTER CARTRIDGE / CARTOUCHE FILTRANTE / CARTUCCIA FILTRO / CARTUCHO DE FILTRO
		93	945634 00000	903800-70000	STIFTSCHRAUBE / STUD / GOUJON PRISONNIER / VITE PRIGIONIERA / PRISIONERO CON ROSCA
		94		947105-00000	SECHSKANTMUTTER / HEX.NUT / ECROU A 6 PANS / DADO ESAGONALE / TUERCA HEXAGONAL
		95		949450-00000	U-SCHEIBE / WASHER / RONDELLE / RONDELLA / ARANDELA
		⑤ /6-29 - Korrosionsschutz - corrosion protection - protection contre la corrosion - protezione anti-corrosione - protección contra la corrosión		6	000111 21300
9	020012 21300			020004-21300	KOLBEN / ROTOR / PISTON / ROTORE / ÉMBOLO
11	901381 00007			901334-00004	SATZ (KIT) SCHIEBER / VANES / PALETTE / PALETTE / EMPUJADOR
15	000811 21300			000801-21300	SEITENDECKEL / LID LATERAL / COUVERCLE LATÉRAL / COPERCHIO LATERALE / TAPA LATERAL
16	000711 21300			000701-21300	SEITENDECKEL / LID LATERAL / COUVERCLE LATÉRAL / COPERCHIO LATERALE / TAPA LATERAL
68				909507-00000	FILTERPATRONE / FILTER CARTRIDGE / CARTOUCHE FILTRE / CARTUCCIA FILTRO / CARTUCHO DE FILTRO
69	909587 00000				FILTERPATRONE (1x POLYESTER) / FILTER CARTRIDGE / CARTOUCHE FILTRE / CARTUCCIA FILTRO / CARTUCHO DE FILTRO
76				025516-21100	DICHTUNG / GASKET / JOINT / GUARNIZIONE / JUNTA
77				022802-21100	FILTERTRÄGER / FILTER HOLDER / SUPPORT FILTRE / SUPPORTO FILTRO / SOPORTE DE FILTRO
83				952019-00000	SPANNHÜLSE / LOCATING PEG / DOUILLE DE ETRAGE / SPINE DI RISCONTRO / CASQUILLO TENSOR
88				560203-21300	KÜHLER / COOLER / REFROIDISSEUR / RAFFREDDATORE / REFRIGERADOR
91				909514-00000	FILTERPATRONE / FILTER CARTRIDGE / CARTOUCHE FILTRANTE / CARTUCCIA FILTRO / CARTUCHO DE FILTRO
93	945634 00000			903800-70000	STIFTSCHRAUBE / STUD / GOUJON PRISONNIER / VITE PRIGIONIERA / PRISIONERO CON ROSCA
94				947105-00000	SECHSKANTMUTTER / HEX.NUT / ECROU A 6 PANS / DADO ESAGONALE / TUERCA HEXAGONAL
95				949450-00000	U-SCHEIBE / WASHER / RONDELLE / RONDELLA / ARANDELA
163	920801 21300			920800-21300	LUFTLEITRING / AIR GUIDE COVER RING / CAPOT DE CANALISATION DE L'AIR / CAPPOTTA DEL CONDOTTARIA / CAPERUZA CONDUCTOR DE AIRE
230	019901 21100				UMLENKSTÜCK / RETURN PIECE / PIECE DE RETOUR / PEZZO INVERSIONE / PIEZA DE DESVIACIÓN
378	903260 00000		DICHTUNG / GASKET / JOINT / GUARNIZIONE / JUNTA		

²⁾ variantenabhängige Bauteile / variant-dependent components / composants variante-dependantes / componenti variante-dispendenti / componentes variante-dependientes

KDT 3.140	Variante 	Pos. ²⁾	Bestell Nr. / Ident No. / No. Identification / No. Identificazione / No. De pedido		Beschreibung / Description / Designation / Designazione / Desripcion	
						
⑥ /6-71 - Korrosionsschutz - corrosion protection - protection contre la corrosion - protezione anti-corrosione - protección contra la corrosión		6	000111 21300	000101-21300	GEHÄUSE / PUMP BODY / CORP DE POMPE / CARCASSA / CARCASA	
		9	020012 21300	020004-21300	KOLBEN / ROTOR / PISTON / ROTORE / ÉMBOLO	
		11	901381 00007	901334-00004	SATZ (KIT) SCHIEBER / VANES / PALETTE / PALETTE / EMPUJADOR	
		15	000811 21300	000801-21300	SEITENDECKEL / LID LATERAL / COUVERCLE LATÉRAL / COPERCHIO LATERALE / TAPA LATERAL	
		16	000711 21300	000701-21300	SEITENDECKEL / LID LATERAL / COUVERCLE LATÉRAL / COPERCHIO LATERALE / TAPA LATERAL	
		68		909507-00000	FILTERPATRONE / FILTER CARTRIDGE / CARTOUCHE FILTRE / CARTUCCIA FILTRO / CARTUCHO DE FILTRO	
		69		909587 00000	FILTERPATRONE (1x POLYESTER) / FILTER CARTRIDGE / CARTOUCHE FILTRE / CARTUCCIA FILTRO / CARTUCHO DE FILTRO	
		73		040205 21300	040204-21300	FILTERDECKEL / FILTER COVER / COUVERCLE DE FILTRE / COPERCHIO FILTRO / TAPA DE FILTRO
		76			025516-21100	DICHTUNG / GASKET / JOINT / GUARNIZIONE / JUNTA
		77			022802-21100	FILTERTRÄGER / FILTER HOLDER / SUPPORT FILTRE / SUPPORTO FILTRO / SOPORTE DE FILTRO
		83			952019-00000	SPANNHÜLSE / LOCATING PEG / DOUILLE DE ETRAGE / SPINE DI RISCONTRO / CASQUILLO TENSOR
		88			560203-21300	KÜHLER / COOLER / REFRIGERISSEUR / RAFFREDDATORE / REFRIGERADOR
		91			909514-00000	FILTERPATRONE / FILTER CARTRIDGE / CARTOUCHE FILTRANTE / CARTUCCIA FILTRO / CARTUCHO DE FILTRO
		93		945634 00000	903800-70000	STIFTSCHRAUBE / STUD / GOUJON PRISONNIER / VITE PRIGIONIERA / PRISIONERO CON ROSCA
		94			947105-00000	SECHSKANTMUTTER / HEX.NUT / ECROU A 6 PANS / DADO ESAGONALE / TUERCA HEXAGONAL
		95			949450-00000	U-SCHEIBE / WASHER / RONDELLE / RONDELLA / ARANDELA
		110		947401 00000	921500-50000	HUTMUTTER / CAP NUT / ÉCROU BORGNE / DADO CIECO / TUERCA DE CAPERUZA
		163		920801 21300	920800-21300	LUFTLEITRING / AIR GUIDE COVER RING / CAPOT DE CANALISATION DE L'AIR / CAPPOTTA DEL CONDOTTARIA / CAPERUZA CONDUCTOR DE AIRE
	230		019901 21100		UMLENKSTÜCK / RETURN PIECE / PIECE DE RETOUR / PEZZO INVERSIONE / PIEZA DE DESVIACIÓN	
	378		903260 00000		DICHTUNG / GASKET / JOINT / GUARNIZIONE / JUNTA	

²⁾ variantenabhängige Bauteile / variant-dependent components / composants variante-dependantes / componenti variante-dispendenti / componentes variante-dependientes

KDT 3.140	Variante 	Pos. ²⁾	Bestell Nr. / Ident No. / No. Identification / No. Identificazione / No. De pedido		Beschreibung / Description / Designation / Designazione / Desripcion
					
⑦ /6-71HD - Korrosionsschutz - corrosion protection - protection contre la corrosion - protezione anti-corrosione - protección contra la corrosión		6	000111 21300	000101-21300	GEHÄUSE / PUMP BODY / CORP DE POMPE / CARCASSA / CARCASA
		9	020012 21300	020004-21300	KOLBEN / ROTOR / PISTON / ROTORE / ÉMBOLO
		11	901385 00007	901334-00004	SATZ (KIT) SCHIEBER / VANES / PALETTE / PALETTE / EMPUJADOR
		15	000811 21300	000801-21300	SEITENDECKEL / LID LATERAL / COUVERCLE LATÉRAL / COPERCHIO LATERALE / TAPA LATERAL
		16	000711 21300	000701-21300	SEITENDECKEL / LID LATERAL / COUVERCLE LATÉRAL / COPERCHIO LATERALE / TAPA LATERAL
		68		909507-00000	FILTERPATRONE / FILTER CARTRIDGE / CARTOUCHE FILTRE / CARTUCCIA FILTRO / CARTUCHO DE FILTRO
		69	909587 00000		FILTERPATRONE (1x POLYESTER) / FILTER CARTRIDGE / CARTOUCHE FILTRE / CARTUCCIA FILTRO / CARTUCHO DE FILTRO
		73	040205 21300	040204-21300	FILTERDECKEL / FILTER COVER / COUVERCLE DE FILTRE / COPERCHIO FILTRO / TAPA DE FILTRO
		76		025516-21100	DICHTUNG / GASKET / JOINT / GUARNIZIONE / JUNTA
		77		022802-21100	FILTERTRÄGER / FILTER HOLDER / SUPPORT FILTRE / SUPPORTO FILTRO / SOPORTE DE FILTRO
		83		952019-00000	SPANNHÜLSE / LOCATING PEG / DOUILLE DE ETRAGE / SPINE DI RISCONTRO / CASQUILLO TENSOR
		88		560203-21300	KÜHLER / COOLER / REFRIGERISSEUR / RAFFREDDATORE / REFRIGERADOR
		91		909514-00000	FILTERPATRONE / FILTER CARTRIDGE / CARTOUCHE FILTRANTE / CARTUCCIA FILTRO / CARTUCHO DE FILTRO
		93	945634 00000	903800-70000	STIFTSCHRAUBE / STUD / GOUJON PRISONNIER / VITE PRIGIONIERA / PRISIONERO CON ROSCA
		94		947105-00000	SECHSKANTMUTTER / HEX.NUT / ECROU A 6 PANS / DADO ESAGONALE / TUERCA HEXAGONAL
		95		949450-00000	U-SCHEIBE / WASHER / RONDELLE / RONDELLA / ARANDELA
		110	947401 00000	921500-50000	HUTMUTTER / CAP NUT / ÉCROU BORGNE / DADO CIECO / TUERCA DE CAPERUZA
		163	920801 21300	920800-21300	LUFTLEITRING / AIR GUIDE COVER RING / CAPOT DE CANALISATION DE L'AIR / CAPPOTTA DEL CONDOTTARIA / CAPERUZA CONDUCTOR DE AIRE
	230	019901 21100		UMLENKSTÜCK / RETURN PIECE / PIECE DE RETOUR / PEZZO INVERSIONE / PIEZA DE DESVIACIÓN	
	378	903260 00000		DICHTUNG / GASKET / JOINT / GUARNIZIONE / JUNTA	

²⁾ variantenabhängige Bauteile / variant-dependent components / composants variante-dependantes / componenti variante-dispendenti / componentes variante-dependientes