

U 4.400

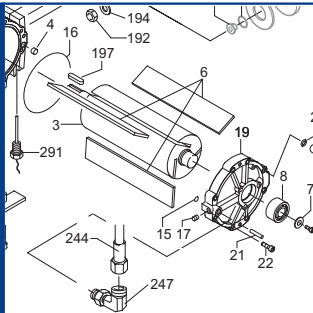

SERVICE

BECKER
D-42279 Wuppertal
www.becker-international.com

year

No **E**

type **U 4.400-XX**

frequency Hz

speed min⁻¹

power required kW

inlet capacity m³/h

pressure + mbar

vacuum - mbar

Made in Germany

Index Variante



Ersatzteilliste
Spare parts list
Liste de pièces de rechange
Listino pezzi di ricambio
Lista de piezas de recambio
Lista de peças sobresselentes
Reserveonderdelenlijst
Atsarginių dalių sąrašas
Varuosad nimekirja
Rezerves daļu saraksts

Reservedelsliste
Reservdelslista
Varaosuettelolo
Reservedelsliste
Wykaz części zamiennych
Tartalékalkatrész lista
Seznam náhradních dílů
Seznam nadomestnih delov
Zoznam náhradných dielov
Rezervni dijelovi popis

Lista pieselor de schimb
Páirteanna spártha liosta
Κατάλογος ανταλλακτικών
Yedek parça listesi
Списък на резервните части
Перечень запасных частей
スベアパーツリスト
예비 부품 목록
备用零件目录

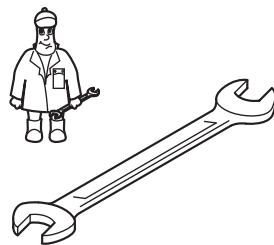

Wartung
Maintenance
Entretien
Manutenzione
Mantenimiento



Pos.	Menge ²⁾ Quantity Quantité Quantità Cantidad	Bestell-Nr. Ident No. No. Identification No. Identificazione No. de pedido	Bezeichnung Description Designation Designazione Descripción
□	1	549000 26700	Dichtungssatz, Complete set of seals, Jeu de joints, Kit di guarnizioni, Junta Completa
6	SATZ/KIT	900580 00003	Schieber, Rotor Vane, Palette, Empujador
89	2	965410 00000	Luftentölelement, Oil separating element, Element separation huile, Cartuccia sepa-ratore olio, Elemento de desaceitar de aire
94	3	506000 12900	Grobabscheider, Coarse separator, Separateur a gros, Separatore grossolano, Separador de solidos gruesos

²⁾ erforderliche Bestellmenge / necessary order quantity / quantité nécessaire / quantità di ordinazione necessari / cantidad necesario

SERVICE
www.becker-international.com
Sales and service network

U 4.400

Standard



Variante



U 4.400/XX

 ①
U 4.400 F/K

 ②
U 4.400 SA/K-25 + F/K-25

 ③④
U 4.400 SA/K-25 + F/K-25

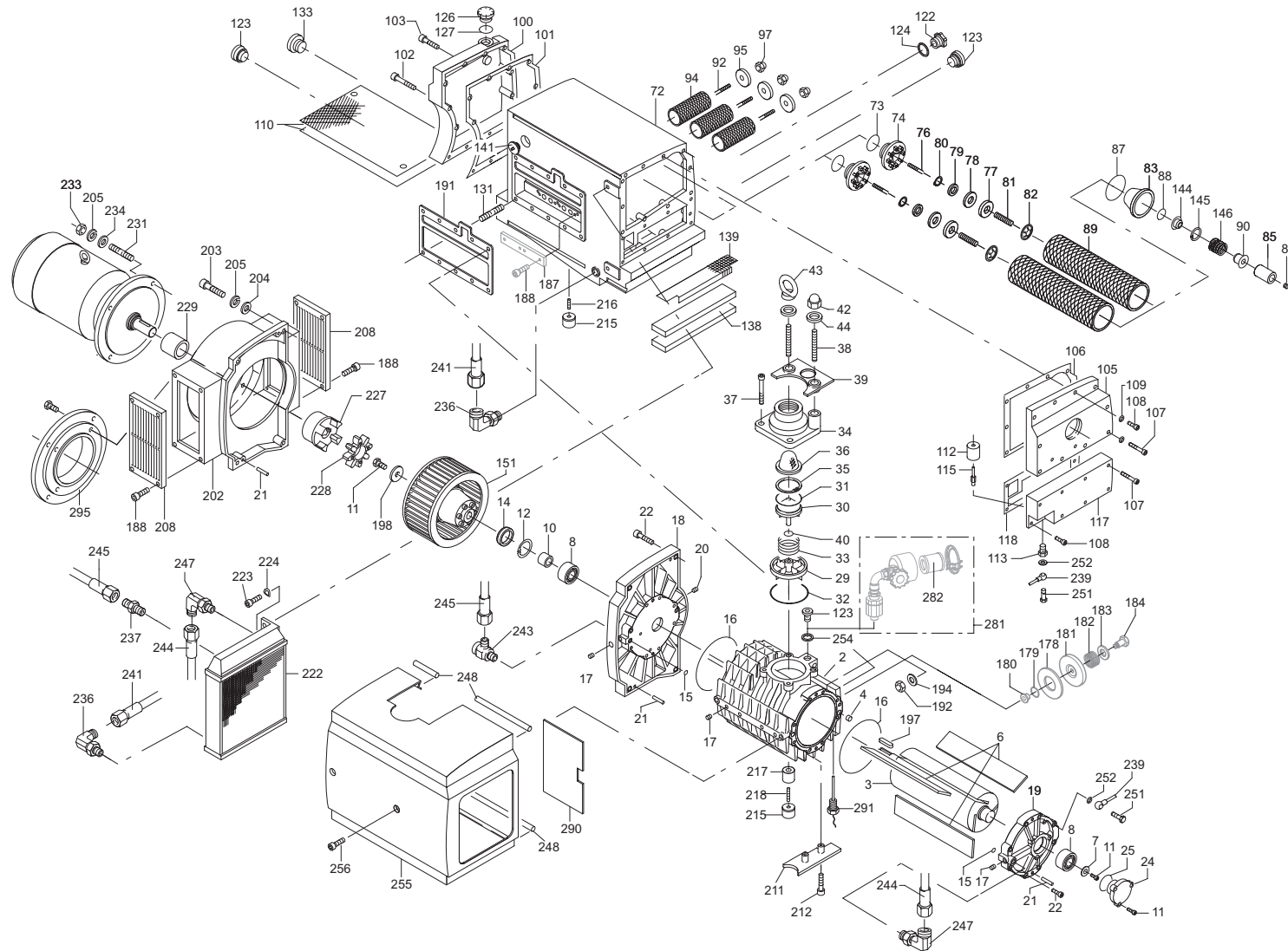
 ⑤⑥
U 4.400 SA/K-51 + F/K-51

SERVICE ?

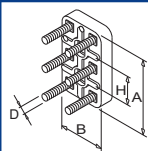
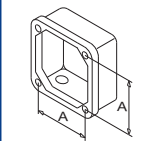
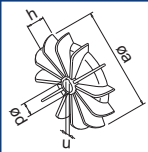
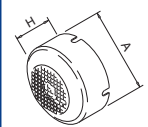
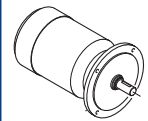



E INDEX	Pos.	Bestell Nr.	Beschreibung	DE	
U 4.400	□	549000 26700	DICHTUNGSSATZ ¹⁾		
	2	000101 26600	GEHÄUSE		
	3	020001 26600	KOLBEN		
	4	912818 00000	VERSCHLUSS-SCHRAUBE		
	6	900580 00003	KUNSTSTOFFSCHIEBER (SATZ) ²⁾		
	7	016803 26600	SCHEIBE		
	8	906605 00000	NADELLAGER		
	9	906600 00700	INNENRING		
	10	906600 00800	INNENRING		
	11	945270 00000	INNENSECHSKANTSCHRAUBE		
	12	948209 10000	SEEGER-RING		
	14	906530 00000	WELLENDICHRING		
	17	912871 00000	VERSCHLUSS-SCHRAUBE		
	18	000801 26600	SEITENDECKEL		
	19	000701 26600	SEITENDECKEL		
20	912820 00000	VERSCHLUSS-SCHRAUBE			
21	948744 00000	KERBSTIFT			
22	945390 00000	INNENSECHSKANTSCHRAUBE			
24	005604 26600	DECKEL			
29	029100 26600	VENTILTRÄGER			
30	033904 26600	VENTILPLATTE			
33	928603 10000	DRUCKFEDER			
34	007800 26600	GEWINDEFLANSCH			
35	948225 00000	SICHERUNGSRING			
36	008000 26600	SIEB			
37	945351 00000	INNENSECHSKANTSCHRAUBE			
38	946967 00000	STIFTSCHRAUBE			
39	003700 26600	DECKEL			
42	947410 00000	HUTMUTTER			
43	951604 00000	RINGMUTTER			
44	947514 00000	U-SCHEIBE			
72	002404 26600	ÖLABSCHEIDERGEHÄUSE			
74	022800 26600	FILTERTRÄGER			
76	951049 02000	STIFTSCHRAUBE			
77	033901 26600	VENTILPLATTE			
78	030700 26600	VENTILSCHEIBE			
79	917551 04000	PASS-SCHEIBE			
80	948128 04000	SEEGERRING			
81	928602 80000	DRUCKFEDER			
82	950185 00000	KLEMMSCHEIBE			
83	005603 26600	DECKEL			
84	945637 00000	GEWINDESTIFT			
85	068010 26600	DISTANZSTÜCK			
89	965410 00000	LUFTENTÖLELEMENT (2x) ²⁾			
90	968008 26600	DISTANZSTÜCK			
92	951041 02000	STIFTSCHRAUBE			
94	506000 12900	GROBABSCHIEDER (3x) ²⁾			
95	905600 21900	DECKEL			
97	947402 00000	HUTMUTTER			
100	002504 26600	ÖLABSCHEIDERDECKEL			
102	945391 00000	INNENSECHSKANTSCHRAUBE			
103	945392 00000	INNENSECHSKANTSCHRAUBE			
105	002500 26600	ÖLABSCHEIDERDECKEL			
107	945353 00000	INNENSECHSKANTSCHRAUBE			
108	945350 00000	INNENSECHSKANTSCHRAUBE			
110	008003 26600	SIEB			
112	867800 99559	SCHWIMMER			
113	912300 00000	ANSCHLUSS-SCHRAUBE			
115	003300 10700	DÜSE			

E INDEX	Pos.	Bestell Nr.	Beschreibung	DE	
	117	002501 26600	ÖLABSCHEIDERDECKEL		
	122	907309 00000	ÖLSCHAUGLAS		
	123	951220 00100	VERSCHLUSS-SCHRAUBE		
	126	916800 10000	SCHRAUBDECKEL		
	131	946945 00000	STIFTSCHRAUBE		
	133	951221 00100	VERSCHLUSS-SCHRAUBE		
	138	064600 26600	FILTERMATTE		
	139	008002 26600	SIEB		
	141	537504 26400	VENTIL		
	144	068006 26600	DISTANZSTÜCK		
	145	948215 00000	SEEGER-RING		
	146	928603 30000	DRUCKFEDER		
	151	502301 26600	KUPPLUNGSHÄLFTE MIT VENTILATOR		
	192	947107 00000	SECHSKANTMUTTER		
	194	948516 00000	FEDERRING		
	197	947820 00000	PASSFEDER		
	198	016803 26600	SCHEIBE		
	199	945270 00000	SCHRAUBE		
	202	053200 26600	LATERNE		
	203	945388 00000	INNENSECHSKANTSCHRAUBE		
	204	947515 00000	U-SCHEIBE		
	205	948511 00000	FEDERRING		
	206	948744 00000	KERBSTIFT		
	208	003702 26600	DECKEL		
	211	003701 26600	DECKEL		
	212	945333 00000	INNENSECHSKANTSCHRAUBE		
	215	741341 00000	GUMMIPUFFER		
	216	945633 00000	GEWINDESTIFT		
	217	068001 26600	DISTANZSTÜCK		
	218	946811 00000	STIFTSCHRAUBE		
	222	560200 26600	KÜHLER KOMPLETT		
	223	945348 00000	INNENSECHSKANTSCHRAUBE		
	224	951710 00000	FEDERSCHEIBE		
	227	902102 26600	MOTORKUPPLUNG		
	228	902227 00000	KUPPLUNGSSCHEIBE		
	229	068004 26600	DISTANZSTÜCK		
	231	946962 00000	STIFTSCHRAUBE		
	233	947109 00000	SECHSKANTMUTTER		
	234	947509 00000	U-SCHEIBE		
	236	961710 00000	WINKEL		
	237	972308 00000	ERMETO-VERSCHRAUBUNG		
	239	512200 26600	ÖLRÜCKFÜHRLEITUNG		
	241	012204 26700	LEITUNG		
	243	761703 01000	ERMETO-VERSCHRAUBUNG		
	244	012206 26600	LEITUNG		
	245	012207 26600	LEITUNG		
	247	961709 00000	WINKEL		
	248	964114 00009	PROFILGUMMI		
	251	009400 19000	KUGELSTÜCKSCHRAUBE		
	255	518300 26600	HAUBE		
	256	945389 00000	INNENSECHSKANTSCHRAUBE		
	281	768704 99626	GASBALLASTVENTIL - OPTIONAL		
	282	740001 05000	FILTERPATRONE, F10		
	290	060900 26600	DÄMPFUNGMATTE		
	291	943400 90000	TEMPERATURFÜHLER		
		960009 00200	BECKER LUBE M 100 (MINERALÖL) - 5L		
		960016 00200	BECKER LUBE S 100 (SYNTHETIKÖL) - 5L		
		960023 00200	BECKER LUBE SL 100 (LEBENSMITTELBEREICH) - 5L		

¹⁾ Dichtungssatz - 549000 26700 - Pos.: 15, 16, 25, 31, 32, 40, 73, 87, 88, 101, 106, 109, 118, 124, 127, 141, 185, 191, 252, 254

²⁾ erforderliche Bestellmenge / Wartung

E INDEX	Pos.	Ident No.	Description	
U 4.400	■	549000 26700	SET OF SEALS ¹⁾	
	2	000101 26600	PUMP BODY	
	3	020001 26600	ROTOR	
	4	912818 00000	SCREWED SEALING PLUG	
	6	900580 00003	PLASTIC VANES (KIT) ²⁾	
	7	016803 26600	WASHER	
	8	906605 00000	NEEDLE BEARING	
	9	906600 00700	INTERIOR RING	
	10	906600 00800	INTERIOR RING	
	11	945270 00000	SOCKET HEAD SCREW	
	12	948209 10000	SEEGER-LOCKRING	
	14	906530 00000	SHAFT SEALING RING	
	17	912871 00000	LOCKING SCREW	
	18	000801 26600	LID	
	19	000701 26600	LID	
20	912820 00000	LOCKING SCREW		
21	948744 00000	GROOVED PIN		
22	945390 00000	SOCKET HEAD SCREW		
24	005604 26600	COVER		
29	029100 26600	VALVE SUPPORT		
30	033904 26600	VALVE PLATE		
33	928603 10000	PRESSURE SPRING		
34	007800 26600	FLANGE		
35	948225 00000	LOCKING RING		
36	008000 26600	SIEVE		
37	945351 00000	SOCKET HEAD SCREW		
38	946967 00000	STUD		
39	003700 26600	COVER		
42	947410 00000	CAP NUT		
43	951604 00000	RING UNIT		
44	947514 00000	WASHER		
72	002404 26600	HOUSING FOR OIL SEPARATION		
74	022800 26600	FILTER HOLDER		
76	951049 02000	STUD		
77	033901 26600	VALVE PLATE		
78	030700 26600	VALVE WASHER		
79	917551 04000	DISTANCE DISC		
80	948128 04000	SEEGER LOCKRING		
81	928602 80000	PRESSURE SPRING		
82	950185 00000	SEEGER-LOCKRING		
83	005603 26600	COVER		
84	945637 00000	THREADED PIN		
85	068010 26600	SPACER BLOCK		
89	965410 00000	OIL SEPARATION ELEMENT (2x) ²⁾		
90	968008 26600	SPACER BLOCK		
92	951041 02000	STUD		
94	506000 12900	COARSE SEPARATOR (3x) ²⁾		
95	905600 21900	COVER		
97	947402 00000	CAP NUT		
100	002504 26600	OIL SEPARATOR COVER		
102	945391 00000	SOCKET HEAD SCREW		
103	945392 00000	SOCKET HEAD SCREW		
105	002500 26600	OIL SEPARATOR COVER		
107	945353 00000	SOCKET HEAD SCREW		
108	945350 00000	SOCKET HEAD SCREW		
110	008003 26600	SIEVE		
112	867800 99559	FLOAT		
113	912300 00000	CONNECTING SCREW		
115	003300 10700	NOZZLE		

E INDEX	Pos.	Ident No.	Description	
	117	002501 26600	OIL SEPARATOR COVER	
	122	907309 00000	OIL SIGHT GLASS	
	123	951220 00100	LOCKING SCREW	
	126	916800 10000	COVER	
	131	946945 00000	STUD	
	133	951221 00100	LOCKING SCREW	
	138	064600 26600	FILTER INSERT	
	139	008002 26600	SIEVE	
	141	537504 26400	VALVE	
	144	068006 26600	SPACER BLOCK	
	145	948215 00000	SEEGER-LOCKRING	
	146	928603 30000	PRESSURE SPRING	
	151	502301 26600	COUPLING WITH FAN	
	192	947107 00000	HEX. NUT	
	194	948516 00000	SPRING WASHER	
	197	947820 00000	KEY	
	198	016803 26600	WASHER	
	199	945270 00000	SCREW	
	202	053200 26600	CONNECTION FLANGE	
	203	945388 00000	SOCKET HEAD SCREW	
	204	947515 00000	WASHER	
	205	948511 00000	SPRING WASHER	
	206	948744 00000	GROOVED PIN	
	208	003702 26600	COVER	
	211	003701 26600	COVER	
	212	945333 00000	SOCKET HEAD SCREW	
	215	741341 00000	RUBBER BUFFER	
	216	945633 00000	THREADED PIN	
	217	068001 26600	SPACING COLLAR	
	218	946811 00000	STUD	
	222	560200 26600	COOLER	
	223	945348 00000	SOCKET HEAD SCREW	
	224	951710 00000	SPRING DISC	
	227	902102 26600	COUPLING MOTOR SIDE	
	228	902227 00000	COUPLING DISC	
	229	068004 26600	SPACER BLOCK	
	231	946962 00000	STUD	
	233	947109 00000	HEX. NUT	
	234	947509 00000	WASHER	
	236	961710 00000	ELBOW	
	237	972308 00000	THREADED JOINT	
	239	512200 26600	OIL RETURN PIPE	
	241	012204 26700	PIPE	
	243	761703 01000	THREADED JOINT	
	244	012206 26600	PIPE	
	245	012207 26600	PIPE	
	247	961709 00000	ELBOW	
	248	964114 00009	RUBBER PROFIL	
	251	009400 19000	HOLLOW HOLDING SCREW	
	255	518300 26600	PROTECTING HOOD	
	256	945389 00000	SOCKET HEAD SCREW	
	281	768704 99626	GAS BALLAST VALVE - OPTIONAL	
	282	740001 05000	FILTER CARTRIDGE, F10	
	290	060900 26600	SILENCER	
	291	943400 90000	TEMPERATURE PROBE	
		960009 00200	BECKER LUBE M 100 (MINERAL OIL) - 5L	
		960016 00200	BECKER LUBE S 100 (SYNTHETIC OIL) - 5L	
		960023 00200	BECKER LUBE SL 100 (FOOD SECTOR) - 5L	

¹⁾ Set of seals - 549000 26700 - Pos.: 15, 16, 25, 31, 32, 40, 73, 87, 88, 101, 106, 109, 118, 124, 127, 141, 185, 191, 252, 254

²⁾ necessary order quantity / maintenance

E INDICE	Pos.	No. Identification	Designation	FR	
U 4.400	■	549000 26700	JEU DE JOINTS ¹⁾		
	2	000101 26600	CARCASSE		
	3	020001 26600	PISTON		
	4	912818 00000	VIS DE FERMETURE		
	6	900580 00003	PALETTE ON PLASTIQUE (KIT) ²⁾		
	7	016803 26600	RONDELLE		
	8	906605 00000	ROULEMENT À AIGUILLES		
	9	906600 00700	BAGUE INTERIEURE		
	10	906600 00800	BAGUE INTERIEURE		
	11	945270 00000	VIS HEXAGONALE INTERNE		
	12	948209 10000	BAGUE DE SURETE		
	14	906530 00000	BAGUE D'ETANCHEITE		
	17	912871 00000	BOUCHON		
	18	000801 26600	COUVERCLE		
	19	000701 26600	COUVERCLE		
20	912820 00000	BOUCHON			
21	948744 00000	GOUPILLE CYLINDRIQUE			
22	945390 00000	VIS HEXAGONALE INTERNE			
24	005604 26600	COUVERCLE			
29	029100 26600	SUPPORT DE SOUPE			
30	033904 26600	CLAPET			
33	928603 10000	RESSORT DE PRESSION			
34	007800 26600	BRIDE			
35	948225 00000	BAGUE DE SURETE			
36	008000 26600	FILTRE			
37	945351 00000	VIS HEXAGONALE INTERNE			
38	946967 00000	TOURILLON			
39	003700 26600	COUVERCLE			
42	947410 00000	ECROU BORGNE			
43	951604 00000	ECROU A ANNEAU			
44	947514 00000	RONDELLE			
72	002404 26600	CARCASSE POUR SEPARATION D'HUILE			
74	022800 26600	SUPPORT FILTRE			
76	951049 02000	TOURILLON			
77	033901 26600	CLAPET			
78	030700 26600	DISQUE DE SOUPE			
79	917551 04000	DISQUE DE TOLERANCE			
80	948128 04000	BAGUE DE SURETE			
81	928602 80000	RESSORT DE PRESSION			
82	950185 00000	BAGUE DE SURETE			
83	005603 26600	COUVERCLE			
84	945637 00000	GOUPILLE FILETEE			
85	068010 26600	PIECE D'ECARTEMENT			
89	965410 00000	ELEMENT SEPARATION HUILE (2x) ²⁾			
90	968008 26600	PIECE D'ECARTEMENT			
92	951041 02000	TOURILLON			
94	506000 12900	SEPARATEUR A GROS (3x) ²⁾			
95	905600 21900	COUVERCLE			
97	947402 00000	ÉCROU BORGNE			
100	002504 26600	COUVERCLE SEPARATEUR D'HUILE			
102	945391 00000	VIS HEXAGONALE INTERNE			
103	945392 00000	VIS HEXAGONALE INTERNE			
105	002500 26600	COUVERCLE DU SEPARATEUR D'HUILE			
107	945353 00000	VIS HEXAGONALE INTERNE			
108	945350 00000	VIS HEXAGONALE INTERNE			
110	008003 26600	TAMIS			
112	867800 99559	PIED CAOUTCHOVE			
113	912300 00000	VIS DE RACCORD			
115	003300 10700	GICLEUR			

E INDICE	Pos.	No. Identification	Designation	FR	
	117	002501 26600	COUVERCLE DU SEPARATEUR D'HUILE		
	122	907309 00000	VERRE REGARD		
	123	951220 00100	BOUCHON		
	126	916800 10000	COUVERCLE		
	131	946945 00000	PRISONNIER		
	133	951221 00100	BOUCHON		
	138	064600 26600	FILTRE DE RECHANGE		
	139	008002 26600	FILTRE		
	141	537504 26400	SOUPE		
	144	068006 26600	PIECE D'ECARTEMENT		
	145	948215 00000	BAGUE DE SURETE		
	146	928603 30000	RESSORT DE PRESSION		
	151	502301 26600	ACCOUPEMENT AVEC VENTILATEUR		
	192	947107 00000	ECROU A 6 PANS		
	194	948516 00000	ANNEAU RESSORT		
	197	947820 00000	CLAVETTE		
	198	016803 26600	RONDELLE		
	199	945270 00000	VIS		
	202	053200 26600	BRIDE DE RACCORDEMENT		
	203	945388 00000	VIS HEXAGONALE INTERNE		
	204	947515 00000	RONDELLE		
	205	948511 00000	ANNEAU RESSORT		
	206	948744 00000	GOUPILLE À ENCOCHES		
	208	003702 26600	COUVERCLE		
	211	003701 26600	COUVERCLE		
	212	945333 00000	VIS HEXAGONALE INTERNE		
	215	741341 00000	AMORTISSEUR EN CAOUTCHOUC		
	216	945633 00000	GOUPILLE FILETEE		
	217	068001 26600	DONILLE D'ECARMENT		
	218	946811 00000	TOURILLON		
	222	560200 26600	REFROIDISSEUR		
	223	945348 00000	VIS HEXAGONALE INTERNE		
	224	951710 00000	DISQUE DE RESSORT		
	227	902102 26600	ACCOUPEMENT MOTEUR		
	228	902227 00000	DISQUE D'ACCOUPEMENT		
	229	068004 26600	PIECE D'ECARTEMENT		
	231	946962 00000	TOURILLON		
	233	947109 00000	ECROU A 6 PANS		
	234	947509 00000	RONDELLE		
	236	961710 00000	COUDES		
	237	972308 00000	RACCORD A VIS		
	239	512200 26600	TUYAU D'HUILE		
	241	012204 26700	TUYAU		
	243	761703 01000	RACCORD A VIS		
	244	012206 26600	TUYAU		
	245	012207 26600	TUYAU		
	247	961709 00000	COUDES		
	248	964114 00009	CAOUTCHOUC PROFILE		
	251	009400 19000	VIS CREUSE DE FIXATION		
	255	518300 26600	CARTER PROTECTEUR		
	256	945389 00000	VIS HEXAGONALE INTERNE		
	281	768704 99626	L'ESTE D'AIR - EN OPTION		
	282	740001 05000	CARTOUCHE FILTRANTE, F10		
	290	060900 26600	AMORTISSEUR		
	291	943400 90000	PALPEUR DE TEMPÉRATURE		
		960009 00200	BECKER LUBE M 100 (HUILE MINÉRALE) - 5L		
		960016 00200	BECKER LUBE S 100 (L'HUILE SYNTHÉTIQUE) - 5L		
		960023 00200	BECKER LUBE SL 100 (SECTEUR DE L'ALIMENTATION) - 5L		

¹⁾ Jeu de joints - 549000 26700 - Pos.: 15, 16, 25, 31, 32, 40, 73, 87, 88, 101, 106, 109, 118, 124, 127, 141, 185, 191, 252, 254

²⁾ quantité nécessaire / entretien

E INDICE	Pos.	No. Identificazione	Designazione	IT	
U 4.400	■	549000 26700	SERIE DI GUARNIZIONE ¹⁾		
	2	000101 26600	CARCASSA		
	3	020001 26600	ROTORE		
	4	912818 00000	TAPPO A VITE		
	6	900580 00003	PALETTA IN PLASTICA (KIT) ²⁾		
	7	016803 26600	RONDELLA		
	8	906605 00000	CUSCINETTO AD AGHI		
	9	906600 00700	ANELLO INTERNO		
	10	906600 00800	ANELLO INTERNO		
	11	945270 00000	VITE ESAGONALE INTERNA		
	12	948209 10000	ANELLO DI SICUREZZA		
	14	906530 00000	ANELLO DI TENUTA		
	17	912871 00000	VITE DI CHIUSURA		
	18	000801 26600	COPERCHIO		
	19	000701 26600	COPERCHIO		
	20	912820 00000	TAPPO A VITE		
	21	948744 00000	PERNO		
	22	945390 00000	VITE ESAGONALE INTERNA		
	24	005604 26600	COPERCHIO		
	29	029100 26600	SEDE DELLA VALVOLA		
	30	033904 26600	SUPPORTO VALVOLA		
	33	928603 10000	MOLLA DELLA PRESSIONE		
	34	007800 26600	FLANGIA		
	35	948225 00000	ANELLO DI SICUREZZA		
	36	008000 26600	FILTRO		
	37	945351 00000	VITE ESAGONALE INTERNA		
	38	946967 00000	L'ASTA A VITE		
	39	003700 26600	COPERCHIO		
	42	947410 00000	DADO CIECO		
	43	951604 00000	GOLFARE CON FORO FILETTATO		
	44	947514 00000	RONDELLA		
	72	002404 26600	CARCASSE SEPARAZIONE OLIO		
	74	022800 26600	SUPPORTO FILTRO		
	76	951049 02000	L'ASTA A VITE		
	77	033901 26600	SUPPORTO VALVOLA		
	78	030700 26600	DISCO DELLA VALVOLA		
	79	917551 04000	DISCO A DISTANZA		
	80	948128 04000	ANELLO DI SICUREZZA		
	81	928602 80000	MOLLA DELLA PRESSIONE		
	82	950185 00000	ANELLO DI SICUREZZA		
	83	005603 26600	COPERCHIO		
	84	945637 00000	SPINA FILETTATURA		
	85	068010 26600	DISTANZIATORE		
	89	965410 00000	CARTUCCIA SEPARATORE OLIO (2x) ²⁾		
	90	968008 26600	DISTANZIATORE		
	92	951041 02000	L'ASTA A VITE		
	94	506000 12900	SEPARATORE GROSSOLANO (3x) ²⁾		
	95	905600 21900	COPERCHIO		
	97	947402 00000	DADO CIECO		
	100	002504 26600	COPERCHIO SEPARATOR OLIO		
	102	945391 00000	VITE ESAGONALE INTERNA		
	103	945392 00000	VITE ESAGONALE INTERNA		
	105	002500 26600	COPERCHIO SEPARATORE OLIO		
	107	945353 00000	VITE ESAGONALE INTERNA		
	108	945350 00000	VITE ESAGONALE INTERNA		
	110	008003 26600	STACCIO		
	112	867800 99559	GALLEGGIANTE		
	113	912300 00000	ATTACO FILETTATO		
	115	003300 10700	UGELLO		

E INDICE	Pos.	No. Identificazione	Designazione	IT	
	117	002501 26600	COPERCHIO SEPARATORE OLIO		
	122	907309 00000	SPIA LIVELLO OLIO		
	123	951220 00100	VITE DI CHIUSURA		
	126	916800 10000	COPERCHIO		
	131	946945 00000	L'ASTA A VITE		
	133	951221 00100	VITE DI CHIUSURA		
	138	064600 26600	FILTRO DI RICAMBIO		
	139	008002 26600	FILTRO		
	141	537504 26400	VALVOLA		
	144	068006 26600	DISTANZIATORE		
	145	948215 00000	ANELLO DI SICUREZZA		
	146	928603 30000	MOLLA DELLA PRESSIONE		
	151	502301 26600	GIUNTO CON VENTILATORE		
	192	947107 00000	DADO ESAGONALE		
	194	948516 00000	RONDELLA GROWER		
	197	947820 00000	CHIAVETTA		
	198	016803 26600	RONDELLA		
	199	945270 00000	VITE		
	202	053200 26600	FLANGIA DI RACCORDE		
	203	945388 00000	VITE ESAGONALE INTERNA		
	204	947515 00000	RONDELLA PIANA		
	205	948511 00000	RONDELLA GROWER		
	206	948744 00000	SPINA SCANALATA		
	208	003702 26600	COPERCHIO		
	211	003701 26600	COPERCHIO		
	212	945333 00000	VITE ESAGONALE INTERNA		
	215	741341 00000	AMMORTIZZATORE IN GOMMA		
	216	945633 00000	VITE SENZA TESTA		
	217	068001 26600	BOCCOLA DISTANZIATRICE		
	218	946811 00000	VITE PRIGIONIERA		
	222	560200 26600	RAFFREDDATORE		
	223	945348 00000	VITE ESAGONALE INTERNA		
	224	951710 00000	DISCO A MOLLA		
	227	902102 26600	GIUNTO MOTORE		
	228	902227 00000	DISCO GIUNTO		
	229	068004 26600	BOCCOLA DISTANZIATRICE		
	231	946962 00000	VITE PRIGIONIERA		
	233	947109 00000	DADO ESAGONALE		
	234	947509 00000	RONDELLA PIANA		
	236	961710 00000	GOMITO		
	237	972308 00000	RACCORDO A VITE		
	239	512200 26600	CONDOTTO OLIO		
	241	012204 26700	CONDOTTO		
	243	761703 01000	RACCORDO A VITE		
	244	012206 26600	CONDOTTO		
	245	012207 26600	CONDOTTO		
	247	961709 00000	GOMITO		
	248	964114 00009	GOMMA PROFILOTO		
	251	009400 19000	VITE PASSAGGIO OLIO		
	255	518300 26600	CARTER DI PROTEZIONE		
	256	945389 00000	VITE ESAGONALE INTERNA		
	281	768704 99626	VALVOLA DI ZAVORATRICE - OPTIONALE		
	282	740001 05000	CARTUCCIA FILTRO, F10		
	290	060900 26600	SILENZIATORE		
	291	943400 90000	PALPATORE DI TEMPERATURA		
		960009 00200	BECKER LUBE M 100 (OLIO MINERALE) - 5L		
		960016 00200	BECKER LUBE S 100 (OLIO SINTETICO) - 5L		
		960023 00200	BECKER LUBE SL 100 (SETTORE ALIMENTARE) - 5L		

¹⁾ Serie di guarnizione - 549000 26700 - Pos.: 15, 16, 25, 31, 32, 40, 73, 87, 88, 101, 106, 109, 118, 124, 127, 141, 185, 191, 252, 254



²⁾ quantità di ordinazione necessari / manutenzione

E INDICE	Pos.	No. De pedido	Descripción	ES	
U 4.400	■	549000 26700	JUNTA COMPLETA ¹⁾		
	2	000101 26600	CARCASA		
	3	020001 26600	ÉMBOLO		
	4	912818 00000	TORNILLO DE CIERRE		
	6	900580 00003	DESPLAZADOR DE PLÁSTICO (KIT) ²⁾		
	7	016803 26600	ARANDELA		
	8	906605 00000	COJINETE DE AGUJAS		
	9	906600 00700	ANILLO INTERIOR		
	10	906600 00800	ANILLO INTERIOR		
	11	945270 00000	TORNILLO HEXAGONAL INTERIOR		
	12	948209 10000	ANILLO DE RETENCIÓN		
	14	906530 00000	ANILLO DE JUNTA DE ÁRBOL		
	17	912871 00000	TORNILLO DE CIERRE		
	18	000801 26600	TAPA LATERAL		
	19	000701 26600	TAPA LATERAL		
20	912820 00000	TORNILLO DE CIERRE			
21	948744 00000	PASADOR CILÍNDRICO ESTRIADO			
22	945390 00000	TORNILLO HEXAGONAL INTERIOR			
24	005604 26600	TAPA			
29	029100 26600	SOPORTE DE VÁLVULA			
30	033904 26600	PLACA DE VÁLVULA			
33	928603 10000	MUELLE DE COMPRESIÓN			
34	007800 26600	BRIDA ROSCADA			
35	948225 00000	ANILLO DE ASEGURAMIENTO			
36	008000 26600	CRIBA			
37	945351 00000	TORNILLO HEXAGONAL INTERIOR			
38	946967 00000	ESPÁRRAGO			
39	003700 26600	TAPA			
42	947410 00000	TUERCA DE CAPERUZA			
43	951604 00000	TUERCA DE CÁNCAMO			
44	947514 00000	ARANDELA			
72	002404 26600	CARCASA DE SEPARADOR DE ACEITE			
74	022800 26600	SOPORTE DE FILTRO			
76	951049 02000	ESPÁRRAGO			
77	033901 26600	PLACA DE VÁLVULA			
78	030700 26600	DISCO DE VÁLVULA			
79	917551 04000	ARANDELA DE AJUSTE			
80	948128 04000	ANILLO DE RETENCIÓN			
81	928602 80000	MUELLE DE COMPRESIÓN			
82	950185 00000	ABRAZADERA DE APRIETE			
83	005603 26600	TAPA			
84	945637 00000	VARILLA ROSCADA			
85	068010 26600	PIEZA DISTANCIADORA			
89	965410 00000	ELEMENTO DE DESACEITAR DE AIRE (2x) ²⁾			
90	968008 26600	PIEZA DISTANCIADORA			
92	951041 02000	ESPÁRRAGO			
94	506000 12900	SEPARADOR DE SÓLIDOS GRUESOS (3x) ²⁾			
95	905600 21900	TAPA			
97	947402 00000	TUERCA CIEGA			
100	002504 26600	TAPA DE SEPARADOR DE ACEITE			
102	945391 00000	TORNILLO HEXAGONAL INTERIOR			
103	945392 00000	TORNILLO HEXAGONAL INTERIOR			
105	002500 26600	TAPA DE SEPARADOR DE ACEITE			
107	945353 00000	TORNILLO HEXAGONAL INTERIOR			
108	945350 00000	TORNILLO HEXAGONAL INTERIOR			
110	008003 26600	CRIBA			
112	867800 99559	FLOTADOR			
113	912300 00000	TORNILLO DE EMPALME			
115	003300 10700	TOBERA			

E INDICE	Pos.	No. De pedido	Descripción	ES	
	117	002501 26600	TAPA DE SEPARADOR DE ACEITE		
	122	907309 00000	CRISTAL MIRILLA DE ACEITE		
	123	951220 00100	TORNILLO DE CIERRE		
	126	916800 10000	TAPA ROSCADA		
	131	946945 00000	ESPÁRRAGO		
	133	951221 00100	TORNILLO DE CIERRE		
	138	064600 26600	ESTERA DE FILTRO		
	139	008002 26600	CRIBA		
	141	537504 26400	VÁLVULA		
	144	068006 26600	PIEZA DISTANCIADORA		
	145	948215 00000	ANILLO DE RETENCIÓN		
	146	928603 30000	MUELLE DE COMPRESIÓN		
	151	502301 26600	MITAD DE ACOPLAMIENTO CON VENTILADOR		
	192	947107 00000	TUERCA HEXAGONAL		
	194	948516 00000	ARANDELA DE MUELLE		
	197	947820 00000	LENGÜETA DE AJUSTE		
	198	016803 26600	ARANDELA		
	199	945270 00000	TORNILLO		
	202	053200 26600	FAROL		
	203	945388 00000	TORNILLO HEXAGONAL INTERIOR		
	204	947515 00000	ARANDELA		
	205	948511 00000	ARANDELA DE MUELLE		
	206	948744 00000	PASADOR ESTRIADO		
	208	003702 26600	TAPA		
	211	003701 26600	TAPA		
	212	945333 00000	TORNILLO HEXAGONAL INTERIOR		
	215	741341 00000	AMORTIGUADOR DE GOMA		
	216	945633 00000	VARILLA ROSCADA		
	217	068001 26600	PIEZA DISTANCIADORA		
	218	946811 00000	ESPÁRRAGO		
	222	560200 26600	REFRIGERADOR COMPLETO		
	223	945348 00000	TORNILLO HEXAGONAL INTERIOR		
	224	951710 00000	ARANDELA ELÁSTICA		
	227	902102 26600	ACOPLAMIENTO DE MOTOR		
	228	902227 00000	DISCO DE ACOPLAMIENTO		
	229	068004 26600	PIEZA DISTANCIADORA		
	231	946962 00000	ESPÁRRAGO		
	233	947109 00000	TUERCA HEXAGONAL		
	234	947509 00000	ARANDELA		
	236	961710 00000	ÁNGULO		
	237	972308 00000	ATORNILLADURA ERMETO		
	239	512200 26600	CONDUCTO DE RETROALIMENTACIÓN DE ACEITE		
	241	012204 26700	CONDUCTO		
	243	761703 01000	ATORNILLADURA ERMETO		
	244	012206 26600	CONDUCTO		
	245	012207 26600	CONDUCTO		
	247	961709 00000	ÁNGULO		
	248	964114 00009	GOMA PERFILADA		
	251	009400 19000	TORNILLO DE PIEZA ESFÉRICA		
	255	518300 26600	CAPERUZA		
	256	945389 00000	TORNILLO HEXAGONAL INTERIOR		
	281	768704 99626	VÁLVULA DE LASTRE DE GAS - OPCIONAL		
	282	740001 05000	CARTUCHO DE FILTRO, F10		
	290	060900 26600	ESTERA DE AMORTIGUADOR		
	291	943400 90000	SENSOR DE TEMPERATURA		
		960009 00200	BECKER LUBE M 100 (ACEITE MINERAL) - 5L		
		960016 00200	BECKER LUBE S 100 (ACEITE SINTÉTICO) - 5L		
		960023 00200	BECKER LUBE SL 100 (SECTOR ALIMENTARIO) - 5L		

¹⁾ Junta completa - 5549000 26700 - Pos.: 15, 16, 25, 31, 32, 40, 73, 87, 88, 101, 106, 109, 118, 124, 127, 141, 185, 191, 252, 254

²⁾ cantidad necesario / mantenimiento

U 4.400	Variante 	Pos. ²⁾	Bestell Nr. / Ident No. / No. Identification / No. Identificazione / No. De pedido		Beschreibung / Description / Designation / Designazione / Desripcion
					
① U 4.400 F/K		78	030701 26600		VENTILSCHEIBE / VALVE WASHER / TETE DE SOUPAPE / DISCO DELLA VALVOLA / DISCO DE VÁLVULA
		179	030702 26600		VENTILSCHEIBE / VALVE WASHER / TETE DE SOUPAPE / DISCO DELLA VALVOLA / DISCO DE VÁLVULA
		180	016802 26600		SPANNSCHEIBE / CLAMPING DISC / DISQUE DE SERRAGE / DISCO DI FISSAGGIO / ARANDELA TENSORA
		181	033901 26600		VENTILPLATTE / VALVE PLATE / CLAPET / SUPPORTO VALVOLA / PLACA DE VÁLVULA
		182	928603 20000		DRUCKFEDER / PRESSURE SPRING / RESSORT DE PRESSION / MOLLA DELLA PRESSIONE / MUELLE DE COMPRESIÓN
		183	016800 26600		SPANNSCHEIBE / CLAMPING DISC / DISQUE DE SERRAGE / DISCO DI FISSAGGIO / ARANDELA TENSORA
		184	028501 26600		VENTILBOLZEN / VALVE BOLT / TIGE DE SOUPAPE / VALVOLA BULLONE / BULÓN DE VÁLVULA
		187	013300 26600		PRALLBLECH / BAFFLE / DÉFLECTEUR / DEFLETTORE / DEFLECTOR
		188	945330 00000		INNENSECHSKANTSCHRAUBE / SOCKET HEAD SCREW / VIS HEXAGONALE INTERNE / VITE ESAGONALE INTERNA / TORNILLO HEXAGONAL INTERIOR
② U 4.400 (USA) (all variants, plus auxiliaries)		34	007801 26600	007800 26600	GEWINDEFLANSCH / FLANGE / BRIDE / FLANGIA / BRIDA ROSCADA
		105	002503 26600	002500 26600	ÖLABSCHEIDERDECKEL / OIL SEPARATOR COVER / COUVERCLE DE SEPARATEUR D'HUILE / COPERCHIO SEPARAZIONE OLIO / TAPA DE SEPARADOR DE ACEITE
		227	902103 26600	902102 26600	MOTORKUPPLUNG / COUPLING MOTORSIDE / ACCOUPLEMENT MOTEUR / GUINTO MOTORE / ACOPLAMIENTO DE MOTOR
		229	068093 26600	068004 26600	DISTANZSTÜCK / SPACER BLOCK / PIECE D'ECARTEMENT / DISTANZIATORE / PIEZA DISTANCIADORA
		295	037900 26600		ZWISCHENFLANSCH / FLANGE / BRIDE / FLANGIA / BRIDA INTERMEDIA
③ U 4.400 SA/K-25 ④ U 4.400 F/K-25 - mit Öl-Wasser-Kühler - with oil-to-water heat exchanger - avec réfrigérant à l'huile et à l'eau - con radiatore ad olio - acqua - con refrigerador aceite-agua		72	002405 26600	002404 26600	ÖLABSCHEIDERGEHÄUSE / HOUSING FOR OIL SEPARATION / CORP DE SEPARATEUR D'HUILE / CARCASSA SEPARAZIONE OLIO / CARCASA DE SEPARADOR DE ACEITE
		116	012400 26600		ZWISCHENSTÜCK / INTERMEDIATE PIECE / BRIDE / FLANGE / PIEZA INTERMEDIA
		121	560202 26600		KÜHLER / COOLER / REFRIGÉRISEUR / RAFFREDDATORE / REFRIGERADOR
⑤ U 4.400 SA/K-51 ⑥ U 4.400 F/K-51 - mit Ölbadheizung, Niveau-Geber und Thermostat - with oil bath heating, level transmitter and heat valve - avec chauffage du bain d'huile, capteur de niveau et thermostat - con riscaldamento a bagno d'olio, indicatore di livello e termostato - con calefacción de baño de aceite, codificador de nivel y termostato		72	002405 26600	002404 26600	ÖLABSCHEIDERGEHÄUSE / HOUSING FOR OIL SEPARATION / CORP DE SEPARATEUR D'HUILE / CARCASSA SEPARAZIONE OLIO / CARCASA DE SEPARADOR DE ACEITE
		121	560201 26600		ROHRHEIZKÖRPER / PIPE HEATER / CORPS DE CHAUFFE / SCALDIGLIA / CALEFACTOR TUBULAR
		129	943400 70000		TEMPERATURWÄCHTER / THERMOSTAT / THERMOSTAT / INTERRUPTORE TERMICO / TERMOSTATO
		130	300300 07000		REDUZIER-NIPPEL / REDUCING BUSHES / MAMELONS REDUITS / RACCORDO DI RIDUZIONE / BOQUILLA DE REDUCCIÓN
		133		954224-00400	
134	741103 99682			NIVEAUGEBER / LEVEL TRANSMITTER / CAPTEUR DE NIVEAU / INDICATORE DI LIVELLO / CODIFICADOR DE NIVEL	

²⁾ variantenabhängige Bauteile / variant-dependent components / composants variante-dependantes / componenti variante-dispendenti / componentes variante-dependientes