

VX 4.25
VX 4.40

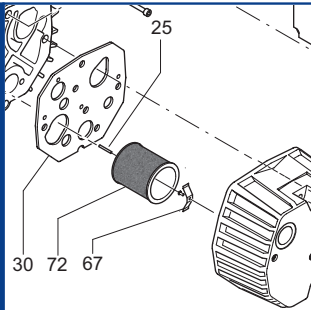

SERVICE

BECKER
D-42279 Wuppertal
www.becker-international.com

year XXXX

No. **A** → **Index Variante**

type **VX 4.25-XX**

frequency XXXX Hz

speed XXXX min⁻¹

power required XXXX kW

inlet capacity XXXX m³/h

pressure + XXXX mbar

vacuum - XXXX mbar

Made in Germany



Ersatzteilliste
Spare parts list
Liste de pièces de rechange
Listino pezzi di ricambio
Lista de piezas de recambio
Lista de peças sobresselentes
Reserveonderdelenlijst
Atsarginių dalių sąrašas
Varuosad nimekirja
Rezerves daļu saraksts

Reservedelsliste
Reservdelslista
Varaosuettelo
Reservedelsliste
Wykaz części zamiennych
Tartalékalkatrész lista
Seznam náhradních dílů
Seznam nadomestnih delov
Zoznam náhradných dielov
Rezervni dijelovi popis

Lista pieselor de schimb
Páirteanna spártha liosta
Κατάλογος ανταλλακτικών
Yedek parça listesi
Списък на резервните части
Перечень запасных частей
スペアパーツリスト
예비 부품 목록
备用零件目录

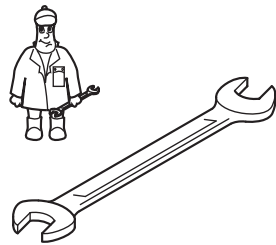

Wartung
Maintenance
Entretien
Manutenzione
Mantenimiento



Pos.	Menge ²⁾ Quantity Quantité Quantità Cantidad	Bestell-Nr. Ident No. No. Identification No. Identificazione No. de pedido	Bezeichnung Description Designation Designazione Descripción
VX 4.25			
24	SATZ/KIT	901399 00007	Schieber, Rotor Vane, Palette, Empujador
72	1	909505 01000	Filterpatrone, Filter cartridge, Cartouche Filtrante, Cartuccia filtro, Cartucho de filtro
VX 4.40			
24	SATZ/KIT	901397 00007	Schieber, Rotor Vane, Palette, Empujador
72	1	909505 01000	Filterpatrone, Filter cartridge, Cartouche Filtrante, Cartuccia filtro, Cartucho de filtro

²⁾ erforderliche Bestellmenge / necessary order quantity / quantité nécessaire / quantità di ordinazione necessari / cantidad necesario

VX 4.25
VX 4.40

Standard



Variante



VX 4.25/XX

- ①
 1~ Einphasenwechselstrom
 1~ single-phase AC
 1~ AC monophasé
 1~ AC monofase
 1~ AC monofásica

- ② /0-44
 - mit externen Filter
 - with external filter
 - avec filtre externe
 - con filtro esterno
 - con filtro externo

VX 4.40/XX

- ③
 1~ Einphasenwechselstrom
 1~ single-phase AC
 1~ AC monophasé
 1~ AC monofase
 1~ AC monofásica

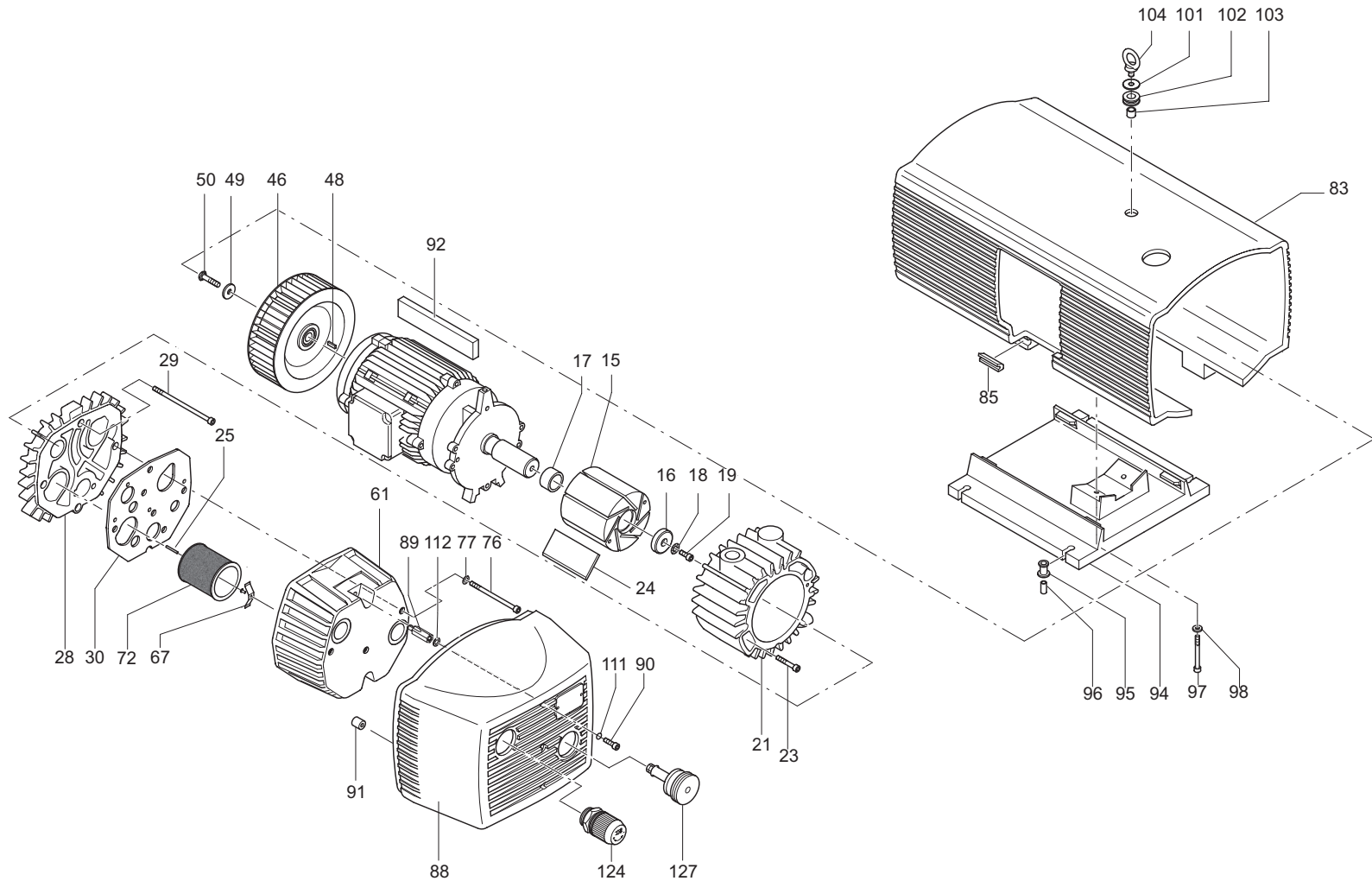

SERVICE ? i

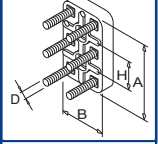
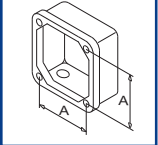
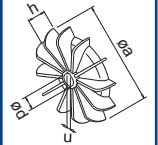
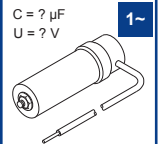
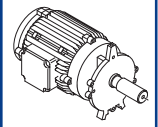

INDEX	Pos.	Bestell Nr.	Beschreibung	DE	
VX 4.25	15	020000 50300	KOLBEN		
	16	016800 16500	SPANNSCHEIBE		
	17	911012 00000	STAR-TOLERANZRING		
	18	949203 00000	ZAHNSCHEIBE		
	19	945320 00000	INNENSECHSKANTSCHRAUBE		
	21	000101 16400	GEHÄUSE		
	23	945320 00000	INNENSECHSKANTSCHRAUBE		
	24	901399 00007	SCHIEBER, KOHLE (SATZ)		
	25	952009 00000	SPANNHÜLSE		
	28	000710 16500	SEITENDECKEL		
	29	945373 00000	INNENSECHSKANTSCHRAUBE		
	30	008900 16500	DICHTUNG		
	46	502301 16400	VENTILATOR MIT NABE		
	48	947713 00000	PASSFEDER		
	49	949454 00000	U-SCHEIBE		
	50	901804 00000	WELLENENDSCHRAUBE TUFLOK		
	61	004803 27600	FILTERDECKEL		
67	009000 16300	ANPRESSFEDER			
72	909505 01000	FILTERPATRONE (1x)¹⁾			
76	945373 00000	INNENSECHSKANTSCHRAUBE			
77	948021 00000	DICHTRING			
83	006805 27500	GERÄTEHAUBE			
85	951920 00000	GUMMIFORMTEIL			
88	006802 27600	GERÄTEHAUBE			
89	068000 27500	DISTANZSTÜCK			
90	945320 00000	INNENSECHSKANTSCHRAUBE			
91	951922 00000	GUMMIFORMTEIL			
92	964110 00000	KANTENSCHUTZ			
94	015100 27600	FUSS			
95	951921 00000	GUMMIFORMTEIL			
96	068000 27600	DISTANZSTÜCK			
97	945328 00000	INNENSECHSKANTSCHRAUBE			
98	949451 00000	UNTERLEGSCHNEIBE			
101	833903 99597	VENTILTELLER			
102	951906 00000	KABELTÜLLE			
103	068002 16500	DISTANZROHR			
104	548800 16300	RINGSCHRAUBE			
111	913161 00000	O-RING			
112	741300 27600	GUMMISCHEIBE			
124	736001 99613	VAKUUMREGULIERVENTIL			
127	727502 06000	ABBLASEVENTIL			

¹⁾ erforderliche Bestellmenge / Wartung

INDEX	Pos.	Bestell Nr.	Beschreibung	DE	
VX 4.40	15	020000 50400	KOLBEN		
	16	016800 16500	SPANNSCHEIBE		
	17	911008 00000	STAR-TOLERANZRING		
	18	949203 00000	ZAHNSCHEIBE		
	19	945320 00000	INNENSECHSKANTSCHRAUBE		
	21	000102 16500	GEHÄUSE		
	23	945322 00000	INNENSECHSKANTSCHRAUBE		
	24	901397 00007	SCHIEBER, KOHLE (SATZ)		
	25	952009 00000	SPANNHÜLSE		
	28	000710 16500	SEITENDECKEL		
	29	945374 00000	INNENSECHSKANTSCHRAUBE		
	30	008900 16500	DICHTUNG		
	46	902300 26200	VENTILATOR MIT NABE		
	48	947713 00000	PASSFEDER		
	49	949454 00000	U-SCHEIBE		
	50	901804 00000	WELLENENDSCHRAUBE TUFLOK		
	61	004803 27600	FILTERDECKEL		
67	009000 16300	ANPRESSFEDER			
72	909505 01000	FILTERPATRONE (1x)¹⁾			
76	945373 00000	INNENSECHSKANTSCHRAUBE			
77	948021 00000	DICHTRING			
83	006801 27600	GERÄTEHAUBE			
85	951920 00000	GUMMIFORMTEIL			
88	006802 27600	GERÄTEHAUBE			
89	068000 27500	DISTANZSTÜCK			
90	945320 00000	INNENSECHSKANTSCHRAUBE			
91	951922 00000	GUMMIFORMTEIL			
92	964109 00000	KANTENSCHUTZ			
94	015100 27600	FUSS			
95	951921 00000	GUMMIFORMTEIL			
96	068000 27600	DISTANZSTÜCK			
97	945328 00000	INNENSECHSKANTSCHRAUBE			
98	949451 00000	UNTERLEGSCHNEIBE			
101	833903 99597	VENTILTELLER			
102	951906 00000	KABELTÜLLE			
103	068002 16500	DISTANZROHR			
104	548800 16300	RINGSCHRAUBE			
111	913161 00000	O-RING			
112	741300 27600	GUMMISCHEIBE			
124	736001 99613	VAKUUMREGULIERVENTIL			
127	727502 06000	ABBLASEVENTIL			

¹⁾ erforderliche Bestellmenge / Wartung

INDEX	Pos.	Ident No.	Description	
VX 4.25	15	020000 50300	ROTOR	
	16	016800 16500	CLAMPING DISC	
	17	911012 00000	STAR-TOLERANCE-RING	
	18	949203 00000	TOOTHED SPRING WASHER	
	19	945320 00000	SOCKET HEAD SCREW	
	21	000101 16400	PUMP BODY	
	23	945320 00000	SOCKET HEAD SCREW	
	24	901399 00007	CARBON VANES (KIT)	
	25	952009 00000	LOCATING PIN	
	28	000710 16500	LID	
	29	945373 00000	SOCKET HEAD SCREW	
	30	008900 16500	GASKET	
46	502301 16400	FAN		
48	947713 00000	KEY		
49	949454 00000	WASHER		
50	901804 00000	SHAFT END BOLT		
61	004803 27600	FILTER COVER		
67	009000 16300	BLADE SPRING		
72	909505 01000	FILTER CARTRIDGE (1x) ¹⁾		
76	945373 00000	SOCKET HEAD SCREW		
77	948021 00000	SEALING RING		
83	006805 27500	PROTECTING HOOD		
85	951920 00000	RUBBER ELEMENT		
88	006802 27600	PROTECTING HOOD (FRONT)		
89	068000 27500	SPACER		
90	945320 00000	SOCKET HEAD SCREW		
91	951922 00000	RUBBER ELEMENT		
92	964110 00000	EDGE PROTECTION		
94	015100 27600	FOOT		
95	951921 00000	RUBBER ELEMENT		
96	068000 27600	SPACING COLLAR		
97	945328 00000	SOCKET HEAD SCREW		
98	949451 00000	WASHER		
101	833903 99597	DISC		
102	951906 00000	RUBBER BUSHING		
103	068002 16500	SPACER TUBE		
104	548800 16300	EYE SCREW		
111	913161 00000	O-RING		
112	741300 27600	RUBBER DISC		
124	736001 99613	VACUUM REGULATING VALVE		
127	727502 06000	BLOW-OFF VALVE		

¹⁾ necessary order quantity / maintenance

INDEX	Pos.	Ident No.	Description	
VX 4.40	15	020000 50400	ROTOR	
	16	016800 16500	CLAMPING DISC	
	17	911008 00000	STAR-TOLERANCE-RING	
	18	949203 00000	TOOTHED SPRING WASHER	
	19	945320 00000	SOCKET HEAD SCREW	
	21	000102 16500	PUMP BODY	
	23	945322 00000	SOCKET HEAD SCREW	
	24	901397 00007	CARBON VANES (KIT)	
	25	952009 00000	LOCATING PIN	
	28	000710 16500	LID	
	29	945374 00000	SOCKET HEAD SCREW	
	30	008900 16500	GASKET	
46	902300 26200	FAN		
48	947713 00000	KEY		
49	949454 00000	WASHER		
50	901804 00000	SHAFT END BOLT		
61	004803 27600	FILTER COVER		
67	009000 16300	BLADE SPRING		
72	909505 01000	FILTER CARTRIDGE (1x) ¹⁾		
76	945373 00000	SOCKET HEAD SCREW		
77	948021 00000	SEALING RING		
83	006801 27600	PROTECTING HOOD		
85	951920 00000	RUBBER ELEMENT		
88	006802 27600	PROTECTING HOOD (FRONT)		
89	068000 27500	SPACER		
90	945320 00000	SOCKET HEAD SCREW		
91	951922 00000	RUBBER ELEMENT		
92	964109 00000	EDGE PROTECTION		
94	015100 27600	FOOT		
95	951921 00000	RUBBER ELEMENT		
96	068000 27600	SPACING COLLAR		
97	945328 00000	SOCKET HEAD SCREW		
98	949451 00000	WASHER		
101	833903 99597	DISC		
102	951906 00000	RUBBER BUSHING		
103	068002 16500	SPACER TUBE		
104	548800 16300	EYE SCREW		
111	913161 00000	O-RING		
112	741300 27600	RUBBER DISC		
124	736001 99613	VACUUM REGULATING VALVE		
127	727502 06000	BLOW-OFF VALVE		

¹⁾ necessary order quantity / maintenance

INDICE	Pos.	No. Identification	Designation	FR	
VX 4.25	15	020000 50300	PISTON		
	16	016800 16500	DISQUE DE SERRAGE		
	17	911012 00000	BAGUE STAR		
	18	949203 00000	DENT DISQUE		
	19	945320 00000	VIS HEXAGONALE INTERNE		
	21	000101 16400	CORP DE POMPE		
	23	945320 00000	VIS HEXAGONALE INTERNE		
	24	901399 00007	PALETTE DE CHARBON (KIT)		
	25	952009 00000	DOVILLE DE ETRAGE		
	28	000710 16500	COUVERCLE		
	29	945373 00000	VIS HEXAGONALE INTERNE		
	30	008900 16500	JOINT		
	46	502301 16400	VENTILATEUR		
	48	947713 00000	CLAVETTE		
	49	949454 00000	RONDELLE		
	50	901804 00000	VIS BOUT D'ARBRE		
	61	004803 27600	COUVERCLE DU FILTRE		
67	009000 16300	RESSORT-JAME			
72	909505 01000	CARTOUCHE FILTRANTE (1x) ¹⁾			
76	945373 00000	VIS HEXAGONALE INTERNE			
77	948021 00000	JOINT			
83	006805 27500	CARTER PROTECTEUR			
85	951920 00000	ELEMENT EN CAOUTCHOUC			
88	006802 27600	CARTER PROTECTEUR			
89	068000 27500	ENTRETOISE			
90	945320 00000	VIS HEXAGONALE INTERNE			
91	951922 00000	ELEMENT EN CAOUTCHOUC			
92	964110 00000	PROTECTION D'ARETE			
94	015100 27600	PIED			
95	951921 00000	ELEMENT EN CAOUTCHOUC			
96	068000 27600	DONILLE D'ECARMENT			
97	945328 00000	VIS HEXAGONALE INTERNE			
98	949451 00000	RONDELLE			
101	833903 99597	PLATEAU DE SOUPE			
102	951906 00000	PROTECTION EN CAOUTCHOUC			
103	068002 16500	TUBE D'ECARTEMENT			
104	548800 16300	PITON			
111	913161 00000	ANNEAU-O			
112	741300 27600	RONDELLE DE CAOUTCHOUC			
124	736001 99613	SOUPE REGLAGE VIDE			
127	727502 06000	SILENCIEUX			

¹⁾ quantité nécessaire / entretien

INDICE	Pos.	No. Identification	Designation	FR	
VX 4.40	15	020000 50400	PISTON		
	16	016800 16500	DISQUE DE SERRAGE		
	17	911008 00000	BAGUE STAR		
	18	949203 00000	DENT DISQUE		
	19	945320 00000	VIS HEXAGONALE INTERNE		
	21	000102 16500	CORP DE POMPE		
	23	945322 00000	VIS HEXAGONALE INTERNE		
	24	901397 00007	PALETTE DE CHARBON (KIT)		
	25	952009 00000	DOVILLE DE ETRAGE		
	28	000710 16500	COUVERCLE		
	29	945374 00000	VIS HEXAGONALE INTERNE		
	30	008900 16500	JOINT		
	46	902300 26200	VENTILATEUR		
	48	947713 00000	CLAVETTE		
	49	949454 00000	RONDELLE		
	50	901804 00000	VIS BOUT D'ARBRE		
	61	004803 27600	COUVERCLE DU FILTRE		
67	009000 16300	RESSORT-JAME			
72	909505 01000	CARTOUCHE FILTRANTE (1x) ¹⁾			
76	945373 00000	VIS HEXAGONALE INTERNE			
77	948021 00000	JOINT			
83	006801 27600	CARTER PROTECTEUR			
85	951920 00000	ELEMENT EN CAOUTCHOUC			
88	006802 27600	CARTER PROTECTEUR			
89	068000 27500	ENTRETOISE			
90	945320 00000	VIS HEXAGONALE INTERNE			
91	951922 00000	ELEMENT EN CAOUTCHOUC			
92	964109 00000	PROTECTION D'ARETE			
94	015100 27600	PIED			
95	951921 00000	ELEMENT EN CAOUTCHOUC			
96	068000 27600	DONILLE D'ECARMENT			
97	945328 00000	VIS HEXAGONALE INTERNE			
98	949451 00000	RONDELLE			
101	833903 99597	PLATEAU DE SOUPE			
102	951906 00000	PROTECTION EN CAOUTCHOUC			
103	068002 16500	TUBE D'ECARTEMENT			
104	548800 16300	PITON			
111	913161 00000	ANNEAU-O			
112	741300 27600	RONDELLE DE CAOUTCHOUC			
124	736001 99613	SOUPE REGLAGE VIDE			
127	727502 06000	SILENCIEUX			

¹⁾ quantité nécessaire / entretien

INDICE	Pos.	No. Identificazione	Designazione		
VX 4.25	15	020000 50300	ROTORE		
	16	016800 16500	DISCO DI FISSAGGIO		
	17	911012 00000	STAR-ANELLO TOLLERANZA		
	18	949203 00000	DISCO A DENTE		
	19	945320 00000	VITE ESAGONALE INTERNA		
	21	000101 16400	CARCASSA		
	23	945320 00000	VITE ESAGONALE INTERNA		
	24	901399 00007	PALETTE DI CHARBONE (KIT)		
	25	952009 00000	SPINE DI RISCONTRO		
	28	000710 16500	COPERCHIO		
	29	945373 00000	VITE ESAGONALE INTERNA		
	30	008900 16500	GUARNIZIONE		
46	502301 16400	VENTILATORE			
48	947713 00000	CHIAVETTA			
49	949454 00000	RONDELLA			
50	901804 00000	VITE DI CHIUSURA ALBERO			
61	004803 27600	COPERCHIO FILTRO			
67	009000 16300	MOLLA			
72	909505 01000	CARTUCCIA FILTRO (1x)¹⁾			
76	945373 00000	VITE ESAGONALE INTERNA			
77	948021 00000	ANELLO GUARNIZIONE			
83	006805 27500	CAPOTO DI PRTEZIONE			
85	951920 00000	ELEMENTO IN GOMMA			
88	006802 27600	CARTER DI PROTEZIONE			
89	068000 27500	SPAZIATORE			
90	945320 00000	VITE ESAGONALE INTERNA			
91	951922 00000	ELEMENTO IN GOMMA			
92	964110 00000	LISTELLO DI PROTEZIONE			
94	015100 27600	PIEDE			
95	951921 00000	ELEMENTO IN GOMMA			
96	068000 27600	BOCCOLA DISTANZIATRICE			
97	945328 00000	VITE ESAGONALE INTERNA			
98	949451 00000	RONDELLA			
101	833903 99597	PIATELLO DELLA VALVOLA			
102	951906 00000	PROTEZIONE IN GOMMA			
103	068002 16500	TUBO DISTANZA			
104	548800 16300	GANCIO			
111	913161 00000	ANELLO-O			
112	741300 27600	RONDELLA IN GOMMA			
124	736001 99613	VALVOLA REGOLAZIONE VUOTO			
127	727502 06000	SILENZIATORE			

¹⁾ quantità di ordinazione necessari / manutenzione

INDICE	Pos.	No. Identificazione	Designazione		
VX 4.40	15	020000 50400	ROTORE		
	16	016800 16500	DISCO DI FISSAGGIO		
	17	911008 00000	STAR-ANELLO TOLLERANZA		
	18	949203 00000	DISCO A DENTE		
	19	945320 00000	VITE ESAGONALE INTERNA		
	21	000102 16500	CARCASSA		
	23	945322 00000	VITE ESAGONALE INTERNA		
	24	901397 00007	PALETTE DI CHARBONE (KIT)		
	25	952009 00000	SPINE DI RISCONTRO		
	28	000710 16500	COPERCHIO		
	29	945374 00000	VITE ESAGONALE INTERNA		
	30	008900 16500	GUARNIZIONE		
46	902300 26200	VENTILATORE			
48	947713 00000	CHIAVETTA			
49	949454 00000	RONDELLA			
50	901804 00000	VITE DI CHIUSURA ALBERO			
61	004803 27600	COPERCHIO FILTRO			
67	009000 16300	MOLLA			
72	909505 01000	CARTUCCIA FILTRO (1x)¹⁾			
76	945373 00000	VITE ESAGONALE INTERNA			
77	948021 00000	ANELLO GUARNIZIONE			
83	006801 27600	CAPOTO DI PRTEZIONE			
85	951920 00000	ELEMENTO IN GOMMA			
88	006802 27600	CARTER DI PROTEZIONE			
89	068000 27500	SPAZIATORE			
90	945320 00000	VITE ESAGONALE INTERNA			
91	951922 00000	ELEMENTO IN GOMMA			
92	964109 00000	LISTELLO DI PROTEZIONE			
94	015100 27600	PIEDE			
95	951921 00000	ELEMENTO IN GOMMA			
96	068000 27600	BOCCOLA DISTANZIATRICE			
97	945328 00000	VITE ESAGONALE INTERNA			
98	949451 00000	RONDELLA			
101	833903 99597	PIATELLO DELLA VALVOLA			
102	951906 00000	PROTEZIONE IN GOMMA			
103	068002 16500	TUBO DISTANZA			
104	548800 16300	GANCIO			
111	913161 00000	ANELLO-O			
112	741300 27600	RONDELLA IN GOMMA			
124	736001 99613	VALVOLA REGOLAZIONE VUOTO			
127	727502 06000	SILENZIATORE			







¹⁾ quantità di ordinazione necessari / manutenzione

INDICE	Pos.	No. De pedido	Descripción	ES	
VX 4.25	15	020000 50300	ÉMBOLO		
	16	016800 16500	ARANDELA TENSORA		
	17	911012 00000	ANILLO DE TOLERANCIA STAR		
	18	949203 00000	POLEA DENTADA		
	19	945320 00000	TORNILLO HEXAGONAL INTERIOR		
	21	000101 16400	CARCASA		
	23	945320 00000	TORNILLO HEXAGONAL INTERIOR		
	24	901399 00007	EMPUJADOR DE CARBÓN (KIT)		
	25	952009 00000	CASQUILLO TENSOR		
	28	000710 16500	TAPA LATERAL		
	29	945373 00000	TORNILLO HEXAGONAL INTERIOR		
	30	008900 16500	JUNTA		
	46	502301 16400	VENTILADOR CON CUBO		
	48	947713 00000	LENGÜETA DE AJUSTE		
	49	949454 00000	ARANDELA		
	50	901804 00000	TORNILLO TERMINAL DE ÁRBOL TUFLOK		
	61	004803 27600	TAPA DE FILTRO		
67	009000 16300	MUELLE DE PRESIÓN			
72	909505 01000	CARTUCHO DE FILTRO (1x)¹⁾			
76	945373 00000	TORNILLO HEXAGONAL INTERIOR			
77	948021 00000	ANILLO DE JUNTA			
83	006805 27500	CAPERUZA DE APARATO			
85	951920 00000	PIEZA DE ORMA DE GOMA			
88	006802 27600	CAPERUZA DE APARATO			
89	068000 27500	PORTABOQUILLA			
90	945320 00000	TORNILLO HEXAGONAL INTERIOR			
91	951922 00000	PIEZA DE ORMA DE GOMA			
92	964110 00000	PROTECCIÓN DE CANTOS			
94	015100 27600	PIE			
95	951921 00000	PIEZA DE ORMA DE GOMA			
96	068000 27600	PIEZA DISTANCIADORA			
97	945328 00000	TORNILLO HEXAGONAL INTERIOR			
98	949451 00000	ARANDELA			
101	833903 99597	PLATILLO DE VÁLVULA			
102	951906 00000	BOQUILLA DE CABLE			
103	068002 16500	TUBO DISTANCIADOR			
104	548800 16300	TORNILLO DE CÁNCAMO			
111	913161 00000	JUNTA TÓRICA			
112	741300 27600	ARANDELA DE GOMA			
124	736001 99613	VÁLVULA REGULADORA DE VACÍO			
127	727502 06000	VÁLVULA DE BARRIDO			

¹⁾ cantidad necesario / mantenimiento

INDICE	Pos.	No. De pedido	Descripción	ES	
VX 4.40	15	020000 50400	ÉMBOLO		
	16	016800 16500	ARANDELA TENSORA		
	17	911008 00000	ANILLO DE TOLERANCIA STAR		
	18	949203 00000	POLEA DENTADA		
	19	945320 00000	TORNILLO HEXAGONAL INTERIOR		
	21	000102 16500	CARCASA		
	23	945322 00000	TORNILLO HEXAGONAL INTERIOR		
	24	901397 00007	EMPUJADOR DE CARBÓN (KIT)		
	25	952009 00000	CASQUILLO TENSOR		
	28	000710 16500	TAPA LATERAL		
	29	945374 00000	TORNILLO HEXAGONAL INTERIOR		
	30	008900 16500	JUNTA		
	46	902300 26200	VENTILADOR CON CUBO		
	48	947713 00000	LENGÜETA DE AJUSTE		
	49	949454 00000	ARANDELA		
	50	901804 00000	TORNILLO TERMINAL DE ÁRBOL TUFLOK		
	61	004803 27600	TAPA DE FILTRO		
67	009000 16300	MUELLE DE PRESIÓN			
72	909505 01000	CARTUCHO DE FILTRO (1x)¹⁾			
76	945373 00000	TORNILLO HEXAGONAL INTERIOR			
77	948021 00000	ANILLO DE JUNTA			
83	006801 27600	CAPERUZA DE APARATO			
85	951920 00000	PIEZA DE ORMA DE GOMA			
88	006802 27600	CAPERUZA DE APARATO			
89	068000 27500	PORTABOQUILLA			
90	945320 00000	TORNILLO HEXAGONAL INTERIOR			
91	951922 00000	PIEZA DE ORMA DE GOMA			
92	964109 00000	PROTECCIÓN DE CANTOS			
94	015100 27600	PIE			
95	951921 00000	PIEZA DE ORMA DE GOMA			
96	068000 27600	PIEZA DISTANCIADORA			
97	945328 00000	TORNILLO HEXAGONAL INTERIOR			
98	949451 00000	ARANDELA			
101	833903 99597	PLATILLO DE VÁLVULA			
102	951906 00000	BOQUILLA DE CABLE			
103	068002 16500	TUBO DISTANCIADOR			
104	548800 16300	TORNILLO DE CÁNCAMO			
111	913161 00000	JUNTA TÓRICA			
112	741300 27600	ARANDELA DE GOMA			
124	736001 99613	VÁLVULA REGULADORA DE VACÍO			
127	727502 06000	VÁLVULA DE BARRIDO			

¹⁾ cantidad necesario / mantenimiento

VX 4.25 VX 4.40	Variante 	Pos. ²⁾	Bestell Nr. / Ident No. / No. Identification / No. Identificazione / No. De pedido		Beschreibung / Description / Designation / Designazione / Descripcion
			  	  	
VX 4.25		8	964233 00000		WINKEL / BRACKET / COUDES / GOMITO / ÁNGULO
① 1~ Einphasenwechselstrom 1~ single-phase AC 1~ AC monofasé 1~ AC monofase 1~ AC monofásica		12	948766 00000		BLINDNIET / BLIND RIVET / RIVET AVEUGLIE / RIVETTO CIEGO / REMACHE CIEGO
		13	742002 30000		KABEL / CABLE / CABLE / CAVO / CABLE
		83	006806 27500	006805-27500	HAUBE / PROTECTING HOOD / CARTER PROTECTEUR / CARTER DI PROTEZIONE / CAPERUZA
		94	015101 27600	015100-27600	FUSS / FOOT / PIED / PIEDE / PIE
② /0-44 3~ ohne Filterung 3~ without filter 3~ sans filtre 3~ senza filtro 3~ sin filtro		25		952009-00000	SPANNHÜLSE / LOCATING PIN / DOVILLE DE ETRAGE / SPINE DI RISCONTRO / CASQUILLO TENSOR
		67		009000-16300	ANPRESSFEDER / LEAF SPRING / RESSORT-JAME / MOLLA / MUELLE DE PRESIÓN
		72		909505-01000	FILTERPATRONE / FILTER CARTRIDGE / CARTOUCHE FILTRANTE / CARTUCCIA FILTRO / CARTUCHO DE FILTRO
		173	840401 05000		FILTERPATRONE FÜR EXTERNEN FILTER (F10) / FILTER CARTRIDGE FOR EXTERNAL FILTER (F10) / CARTOUCHE FILTRANTE POUR FILTRE EXTERNE (F10) / CARTUCCIA FILTRO PER FILTRO ESTERNO (F10) / CARTUCHO DE FILTRO DE FILTRO EXTERNO (F10)
VX 4.40		8	964233 00000		WINKEL / BRACKET / COUDES / GOMITO / ÁNGULO
③ 1~ Einphasenwechselstrom 1~ single-phase AC 1~ AC monofasé 1~ AC monofase 1~ AC monofásica		12	948766 00000		BLINDNIET / BLIND RIVET / RIVET AVEUGLIE / RIVETTO CIEGO / REMACHE CIEGO
		13	742002 30000		KABEL / CABLE / CABLE / CAVO / CABLE
		83	006805 27600	006801-27600	HAUBE / PROTECTING HOOD / CARTER PROTECTEUR / CARTER DI PROTEZIONE / CAPERUZA
		94	015101 27600	015100-27600	FUSS / FOOT / PIED / PIEDE / PIE

²⁾ variantenabhängige Bauteile / variant-dependent components / composants variante-dependantes / componenti variante-dispendenti / componentes variante-dependientes